

**Articulation**

**Homework**

**Helpers**

**/R/ -sound**

Dear \_\_\_\_\_,

We are working on the /r/ sound in speech therapy in the:

initial      medial      final      mixed

position(s) of:

words      sentences      conversation

Please provide these reminders when working on this sound at home:

1) \_\_\_\_\_

2) \_\_\_\_\_

3) \_\_\_\_\_

Please try to practice:

\_\_\_\_\_ times a week for \_\_\_\_\_ minutes

Thank you for your support!

\_\_\_\_\_

**Articulation**

**Homework**

**Helpers**

**/R/ -sound  
initial position**

Cut out the cards below and on the page that follows.  
Practice working on the /r/ sound while you play "memory".

\*Please note that the fruit pictured below is a raspberry.

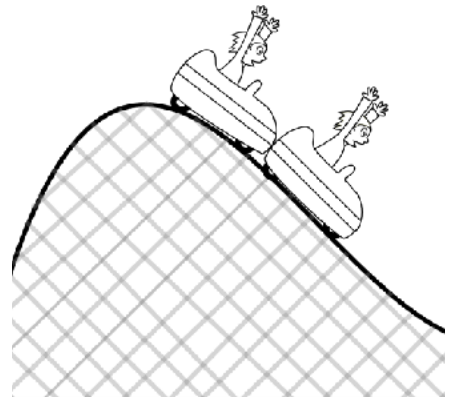
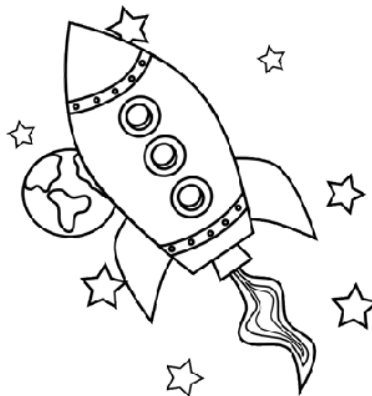
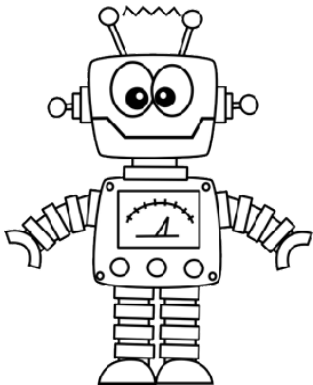
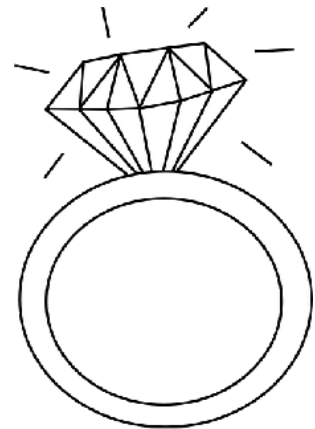
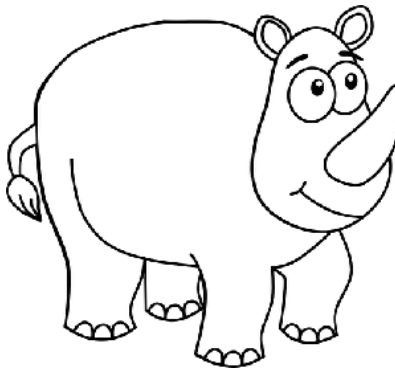
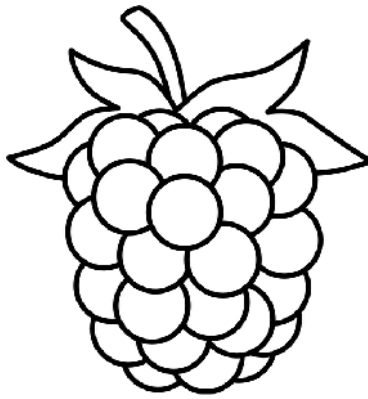
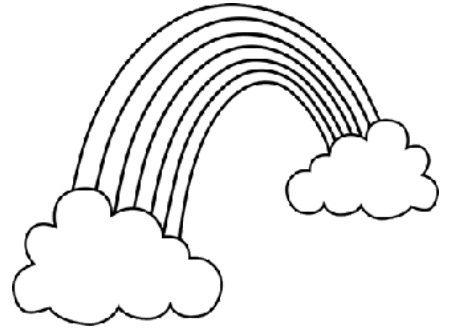

Cut out the cards below and practice working on the /r/ sound while you play "memory".

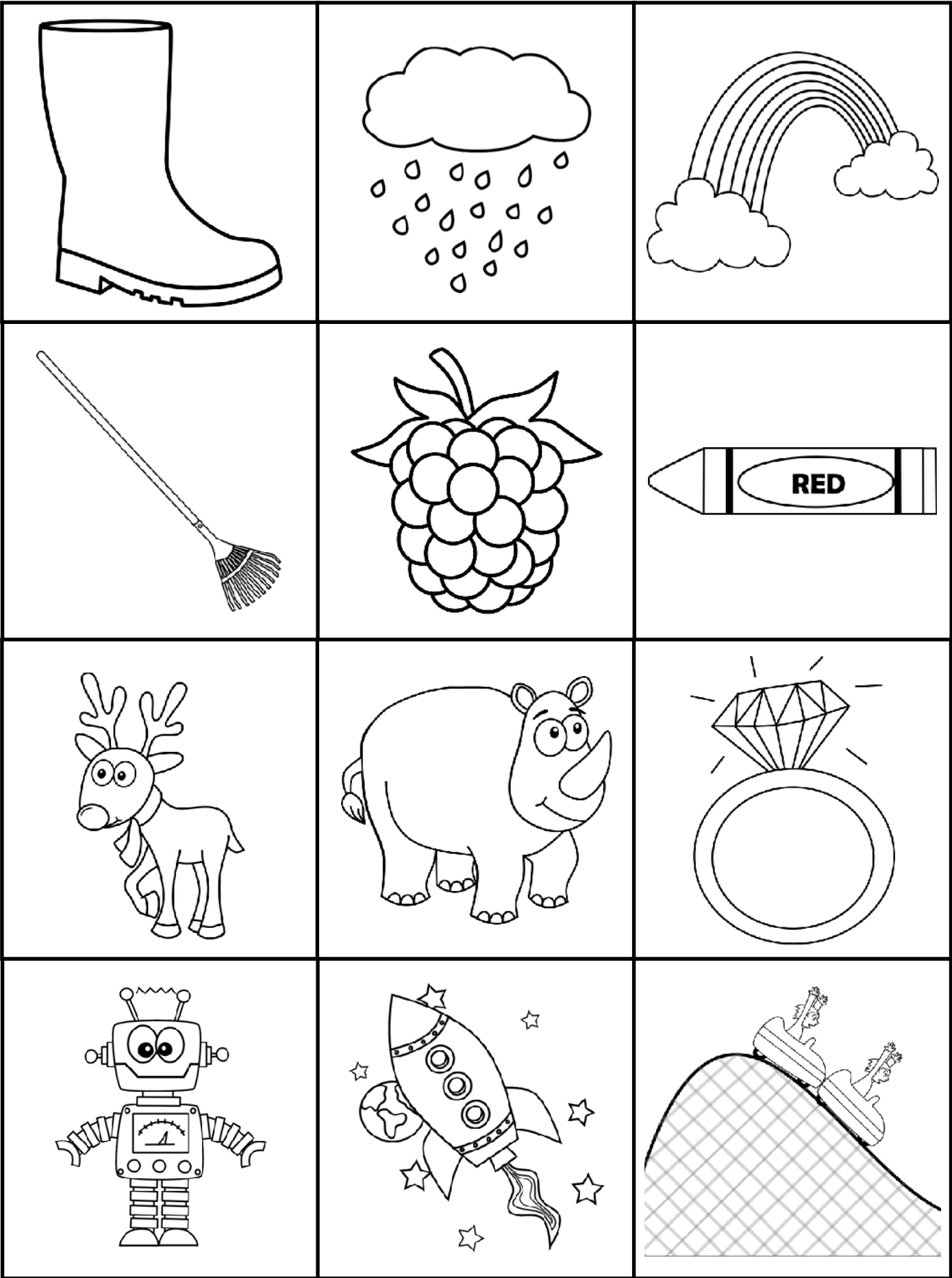

## Tic-Tac-Toe

Cut out the boxes on the page that follows. Then, place the x's and o's on the board as you play tic-tac-toe with a partner.

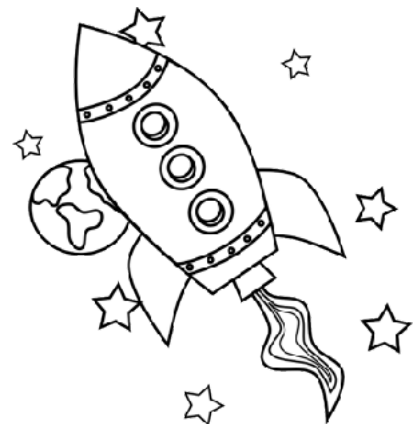
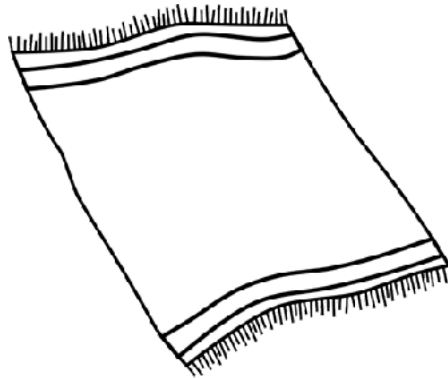
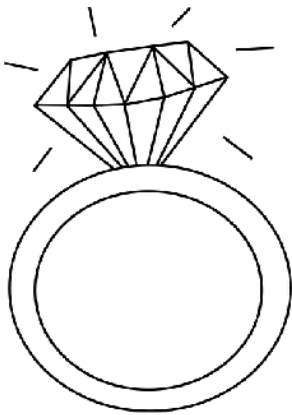
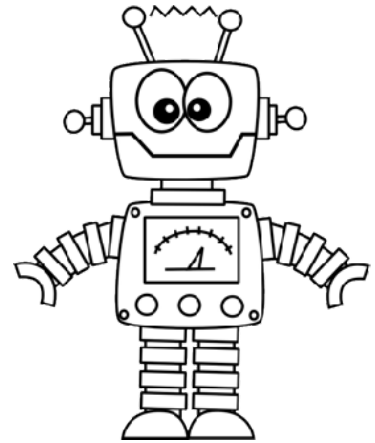
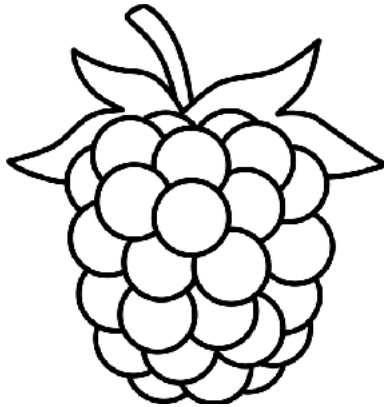
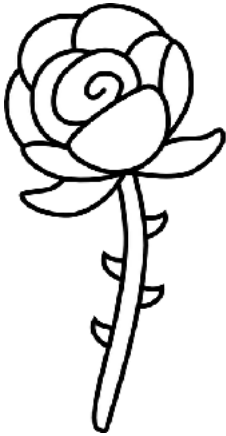

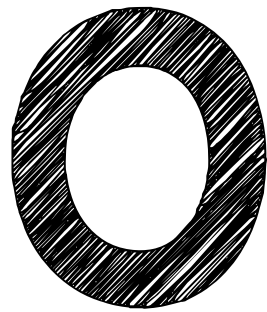
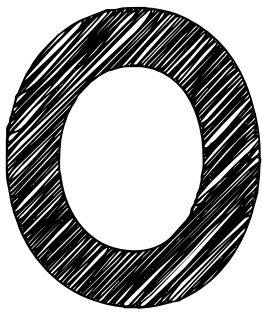
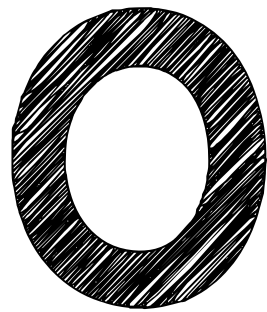
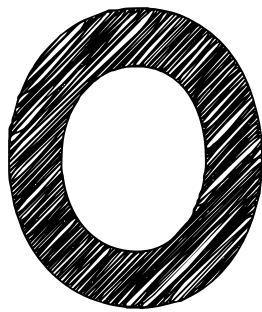
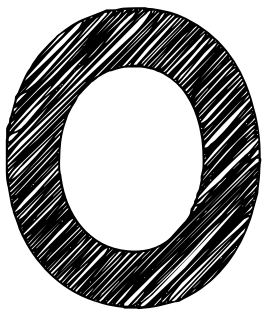
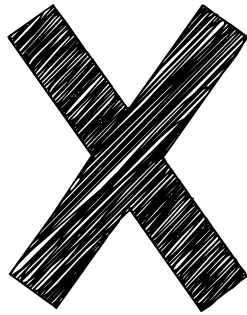
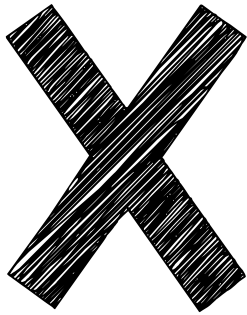

Color or dab a dot, each time you say a word that is pictured.

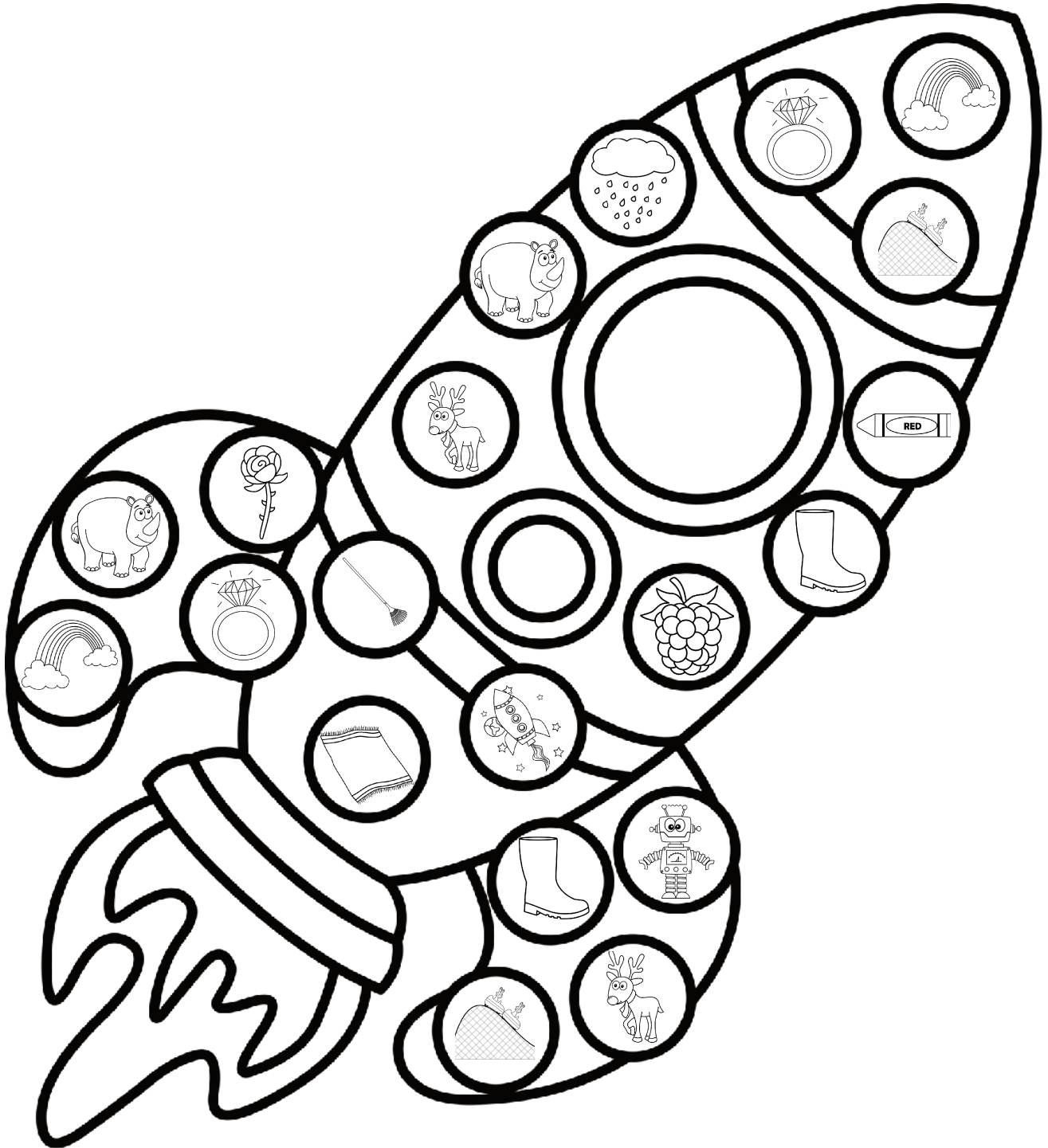



Each time you say a word that is pictured, color or dab a dot.

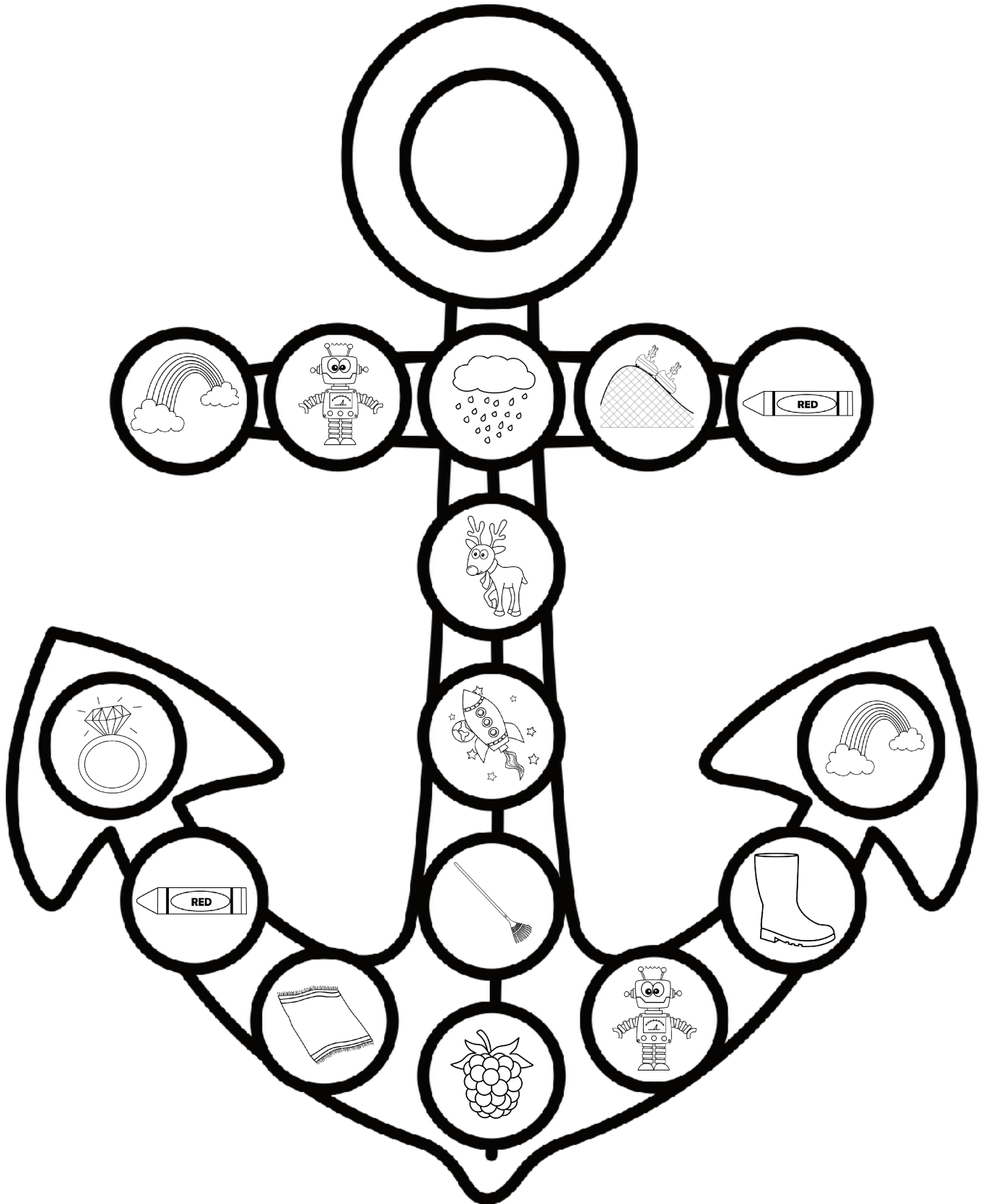

Use a pencil to secure a paper clip over the middle of the spinner. Then, spin the paper clip. When it stops, say the word that word in a sentence, then color it.

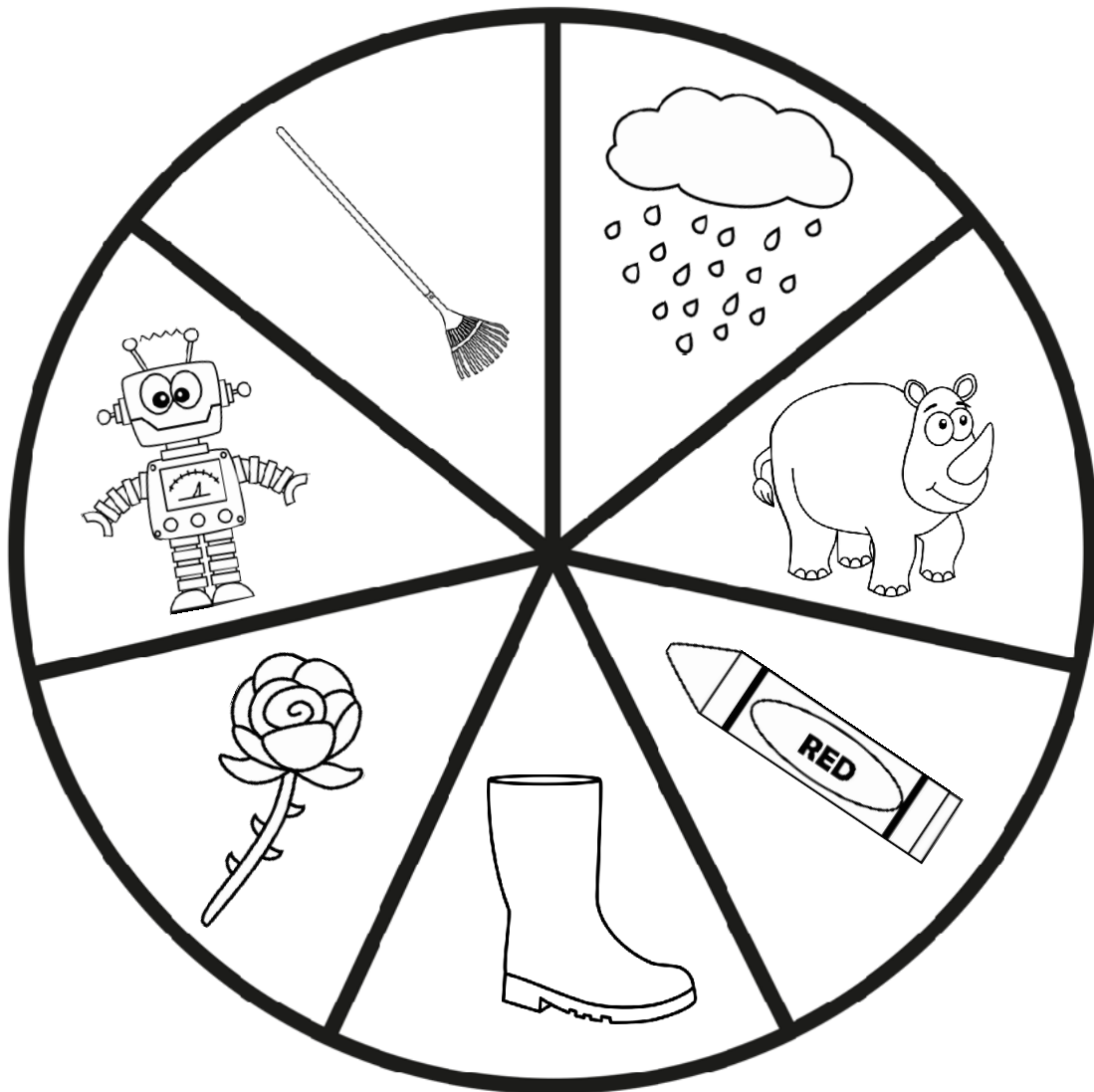

**Cut apart the puzzle pieces. Put them back together, while making up a silly story using the words pictured.**

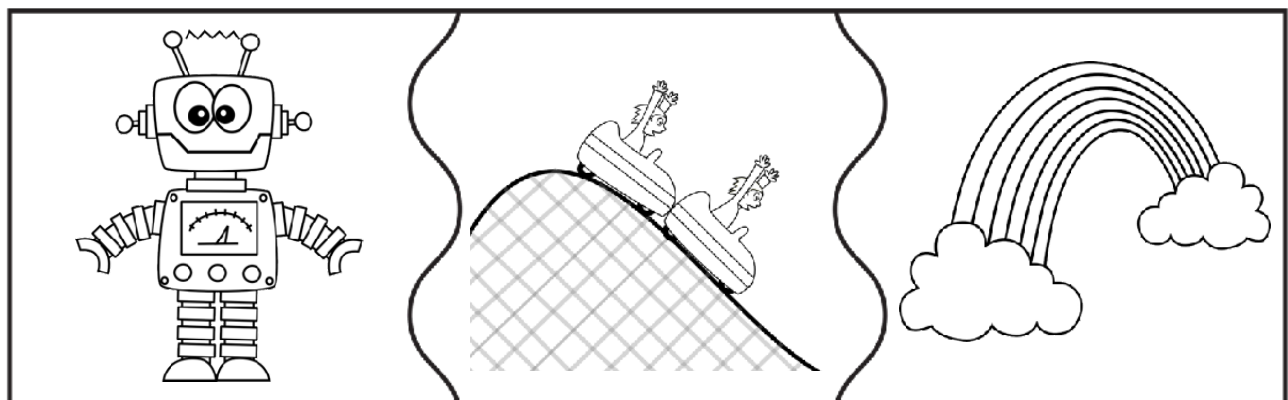
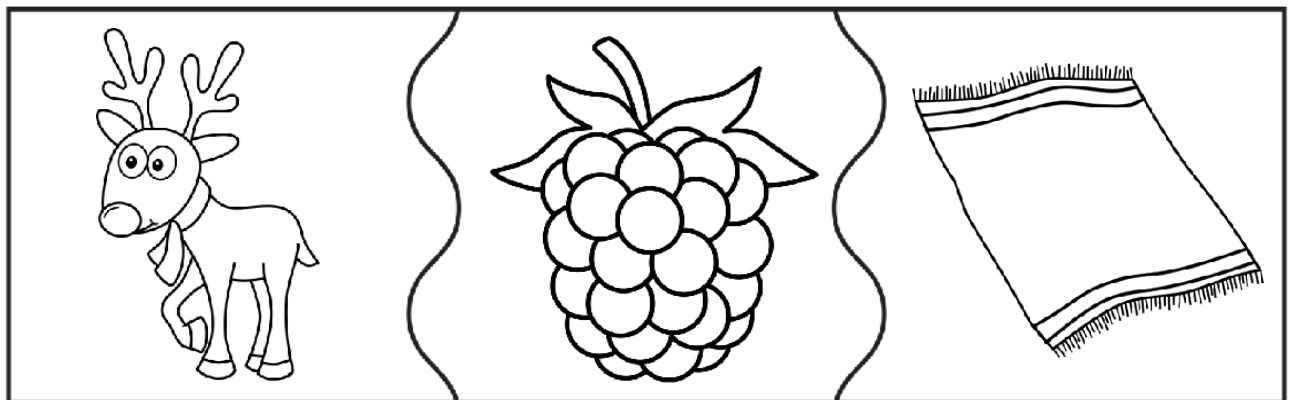
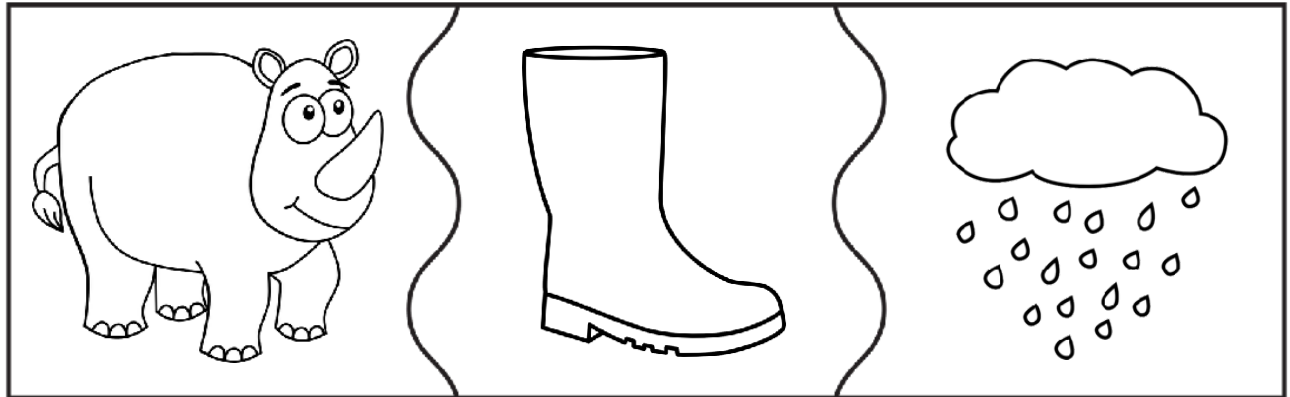

**Articulation**

**Homework**







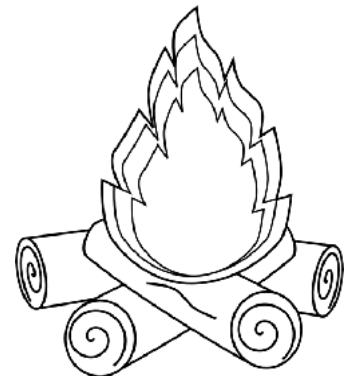
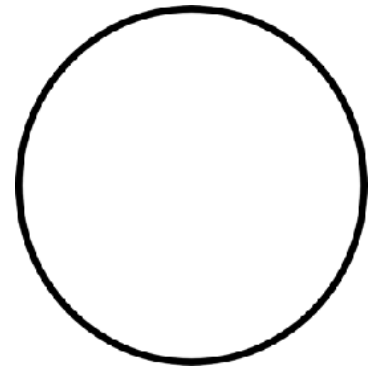
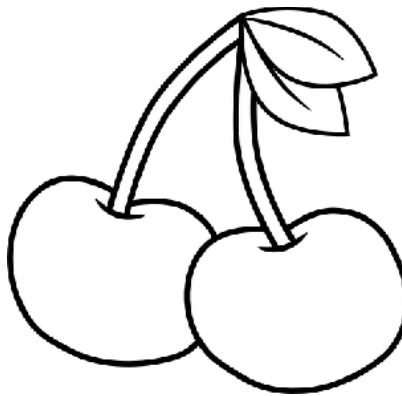
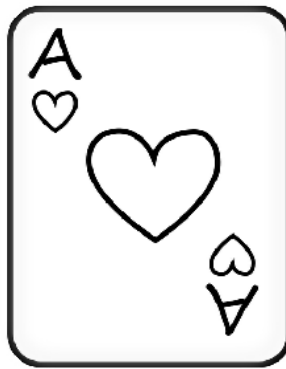
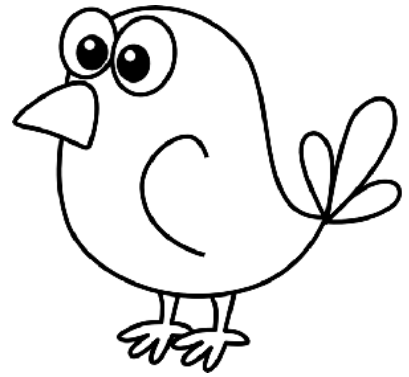
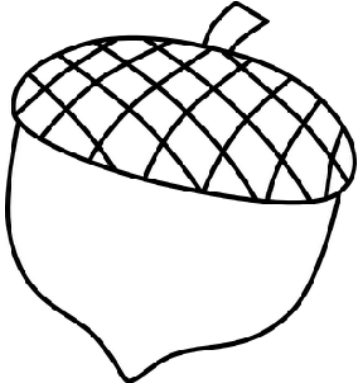

**Helpers**

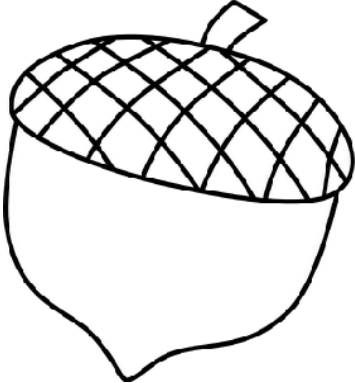
*/R/ -sound  
medial position*

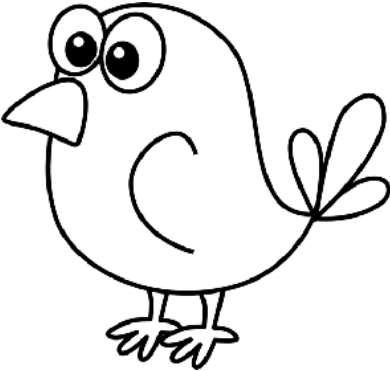
Cut out the cards below and on the page that follows.  
Practice working on the /r/ sound while you play "memory".

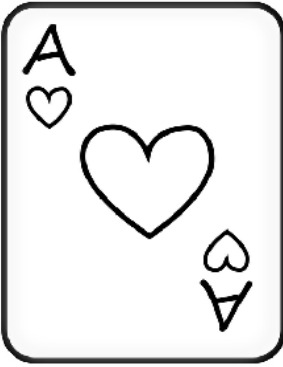

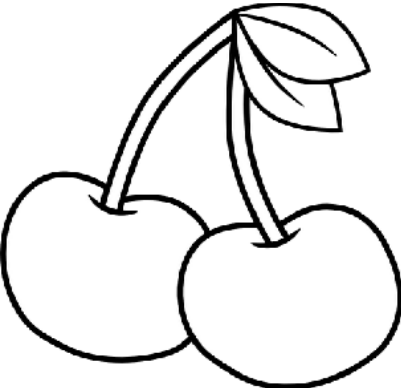
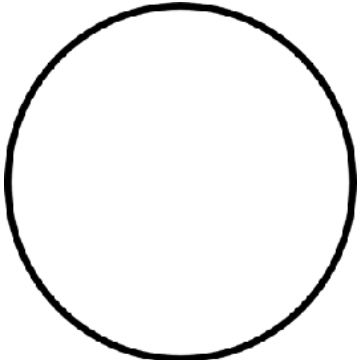
Cut out the cards below and practice working on the /r/ sound while you play "memory".

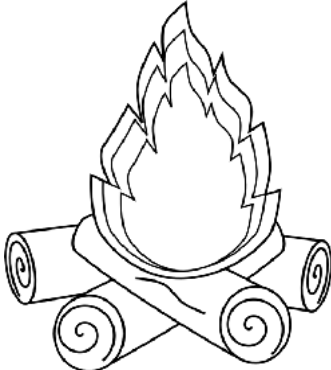
## Tic-Tac-Toe

Cut out the boxes on the page that follows. Then, place the x's and o's on the board as you play tic-tac-toe with a partner.



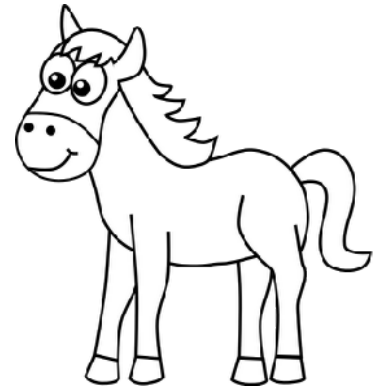
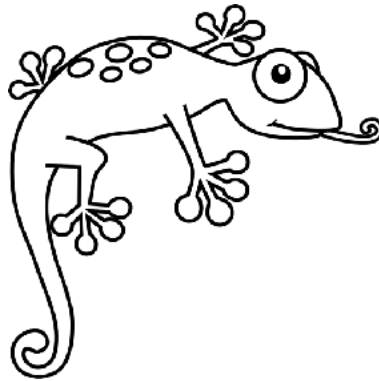
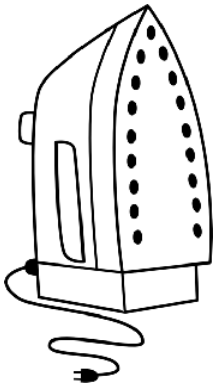
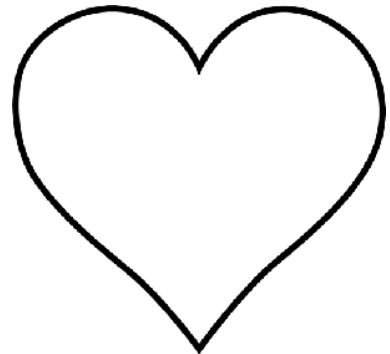
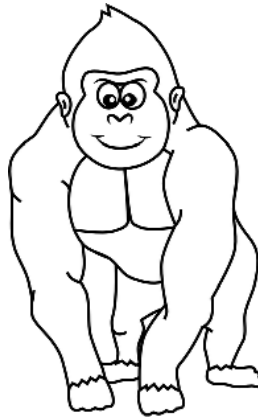
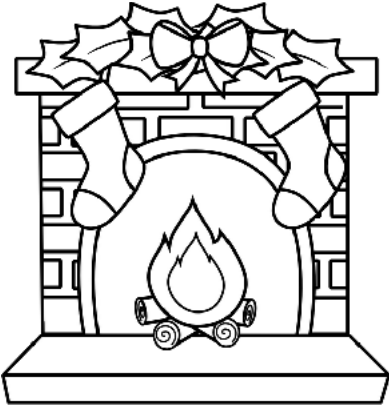

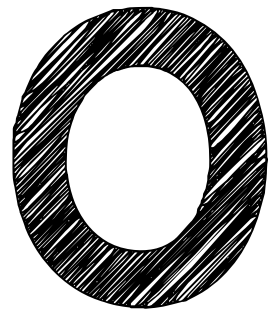
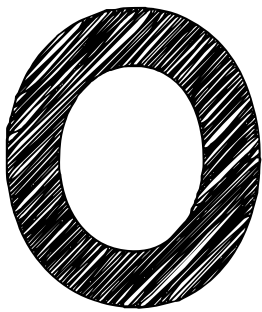
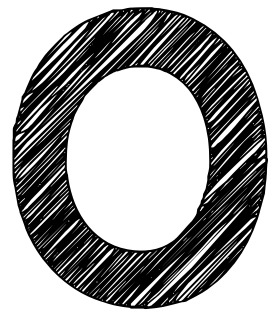
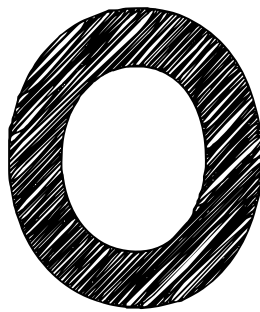
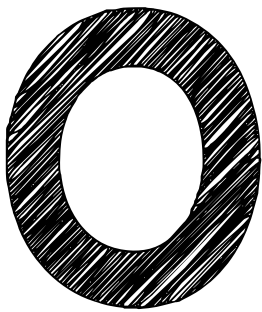
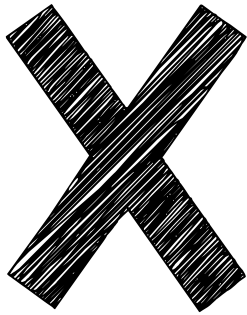

Color or dab a dot, each time you say a word that is pictured.

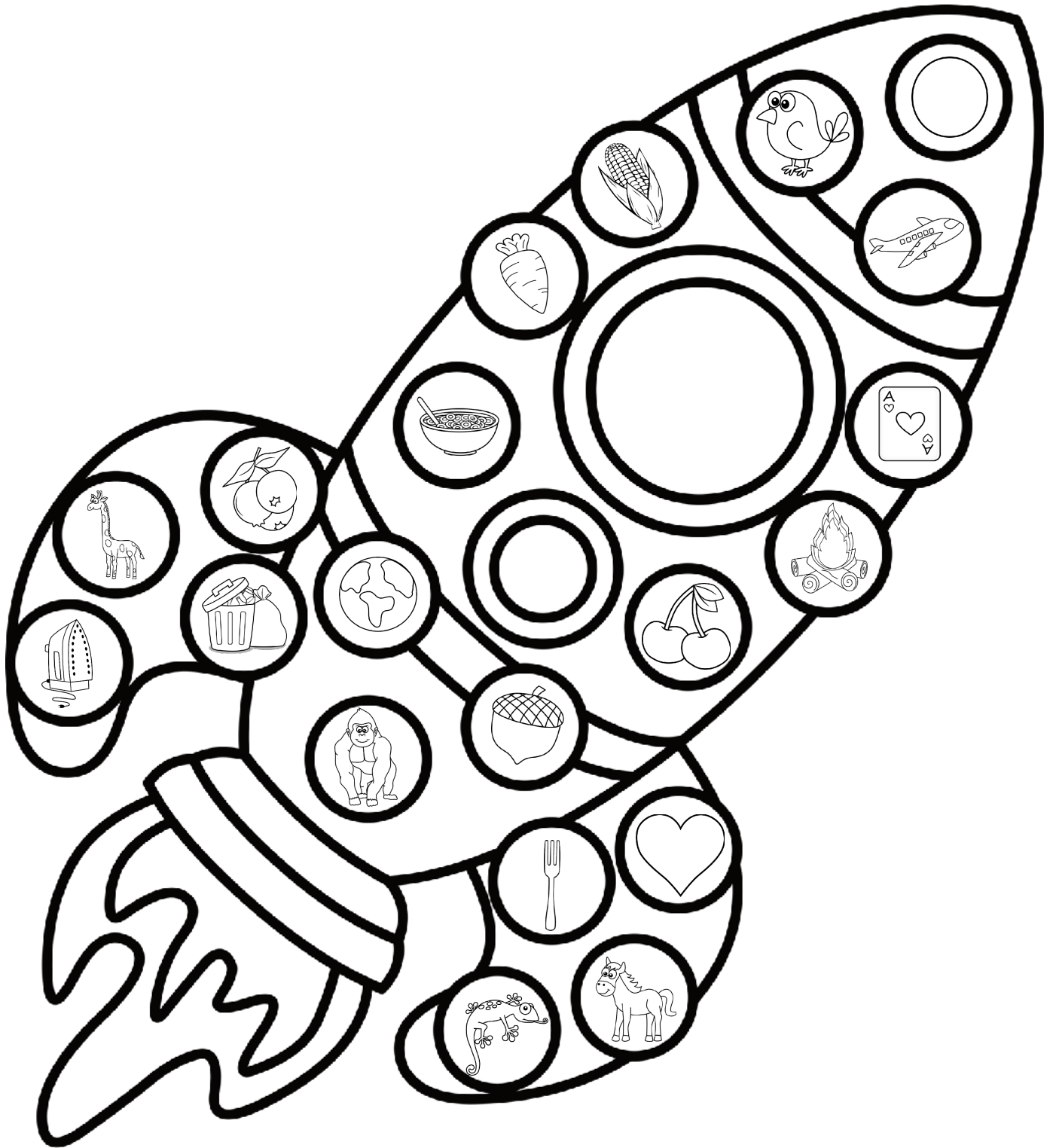

Each time you say a word that is pictured, color or dab a dot.

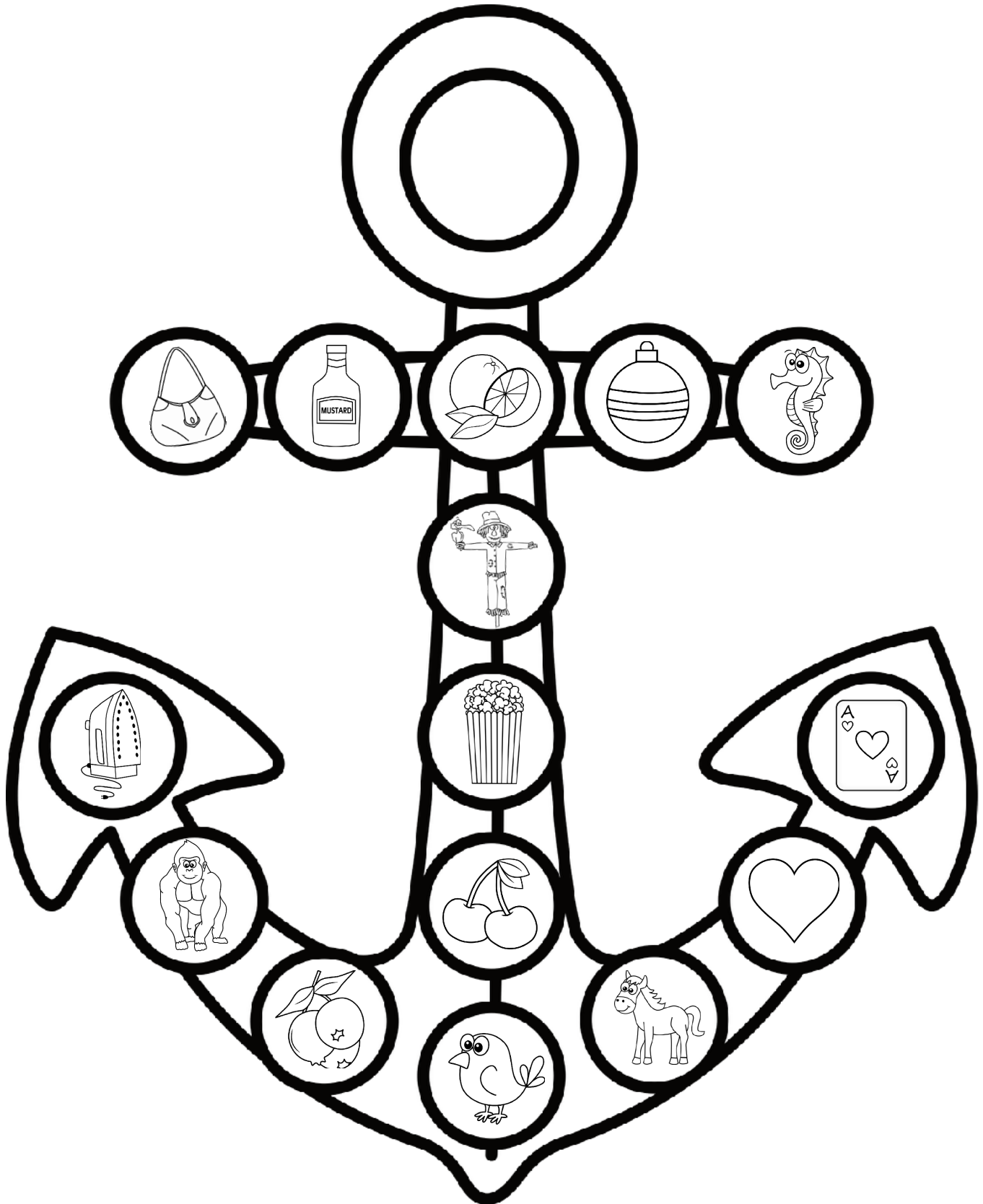

Use a pencil to secure a paper clip over the middle of the spinner. Then, spin the paper clip. When it stops, say the word that word in a sentence, then color it.

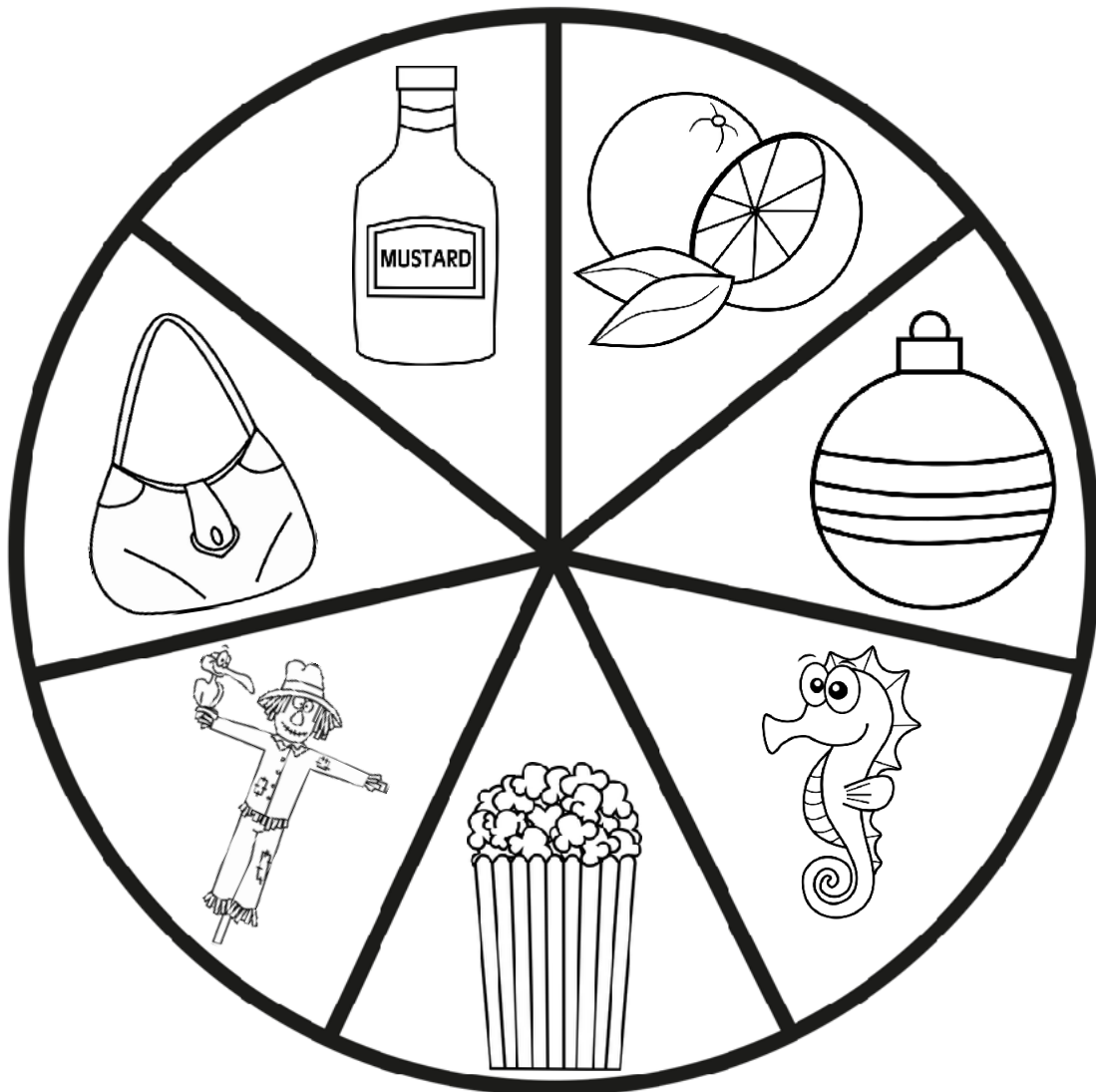

**Cut apart the puzzle pieces. Put them back together, while making up a silly story using the words pictured.**

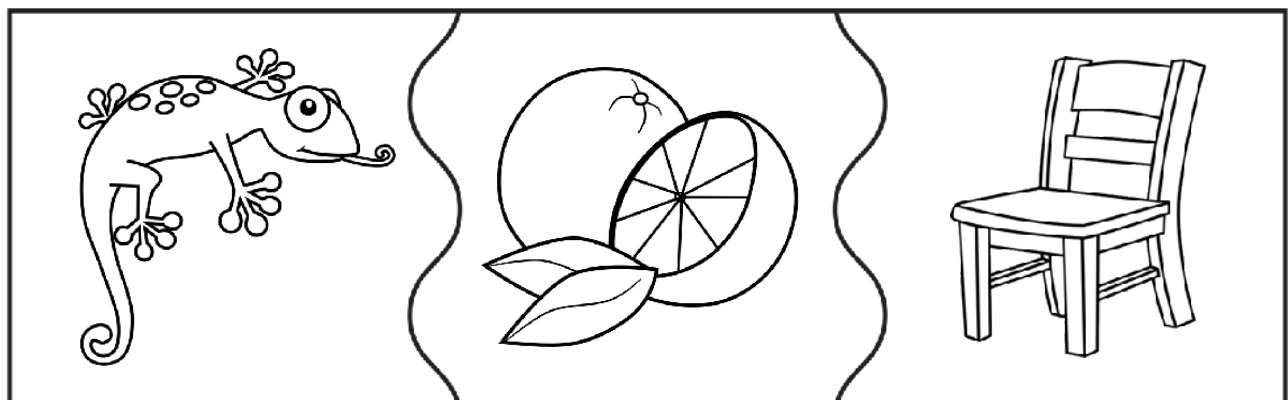
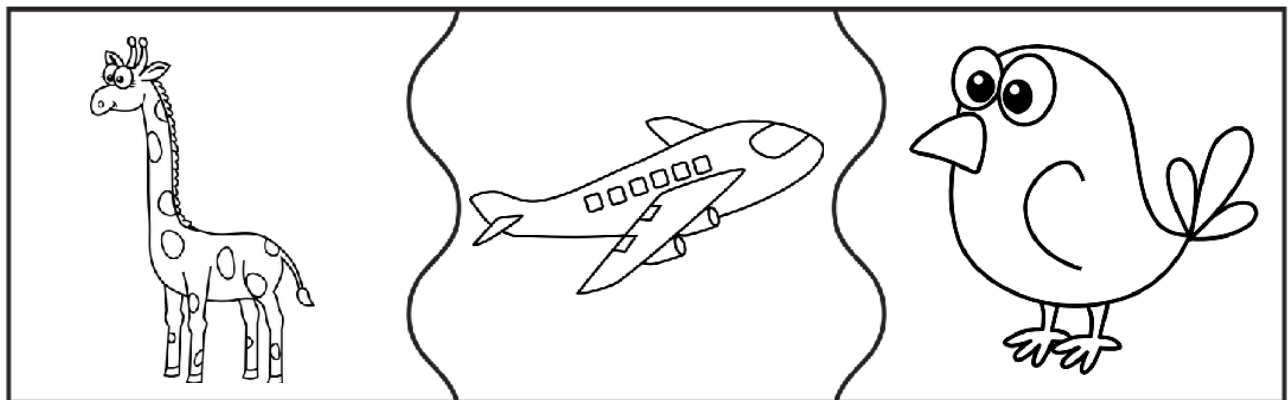
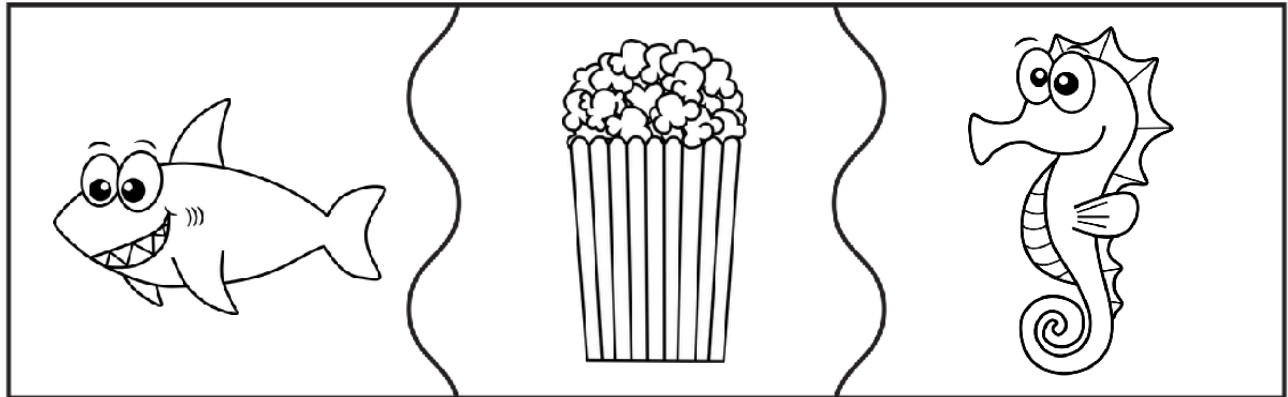

# Articulation Homework Helpers

*/R/ -sound  
final position*

Cut out the cards below and on the page that follows.  
Practice working on the /r/ sound while you play "memory".

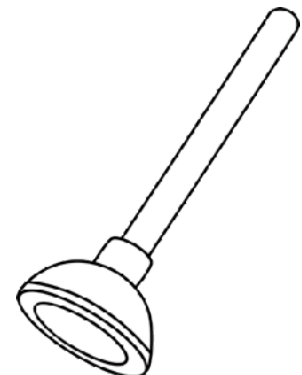
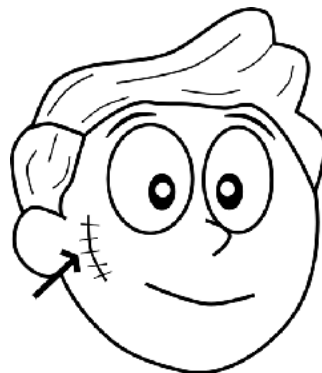
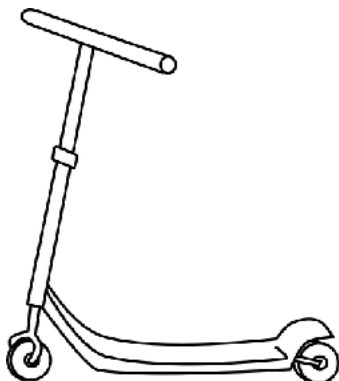
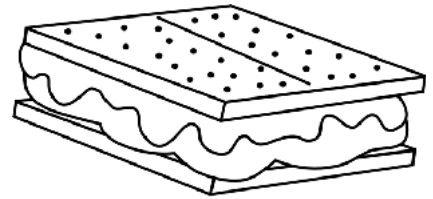
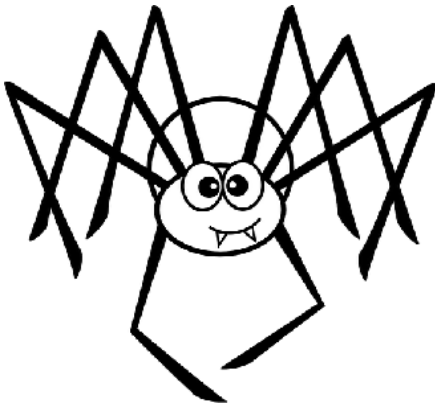
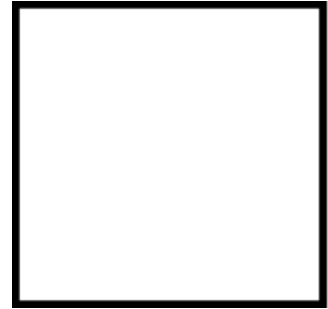
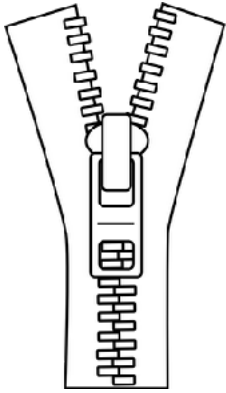

Cut out the cards below and practice working on the /r/ sound while you play "memory".

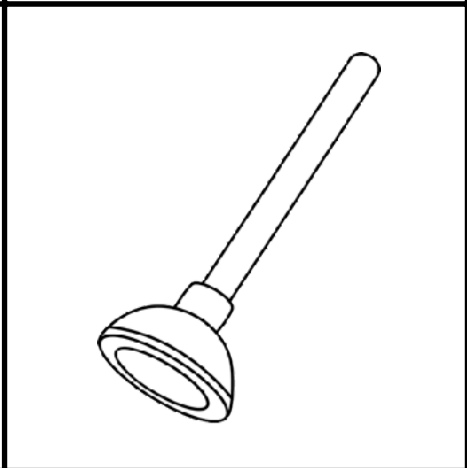
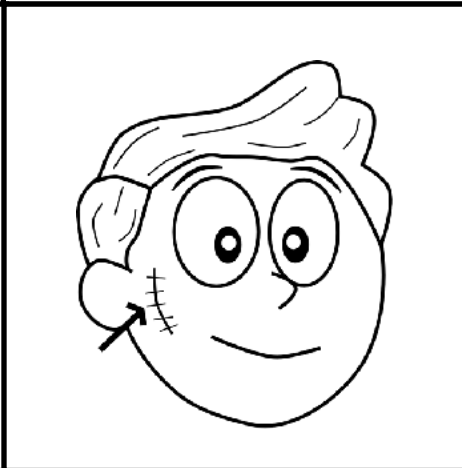
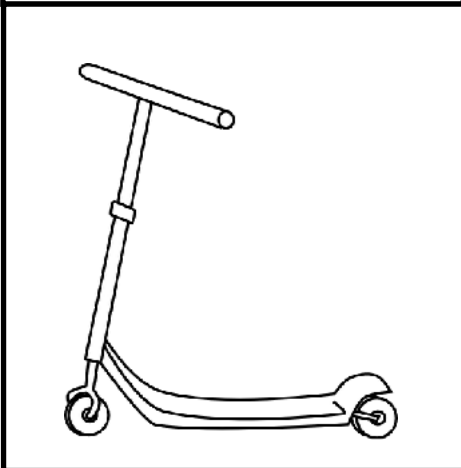
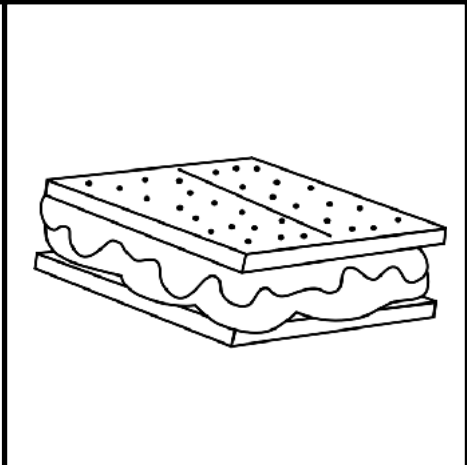
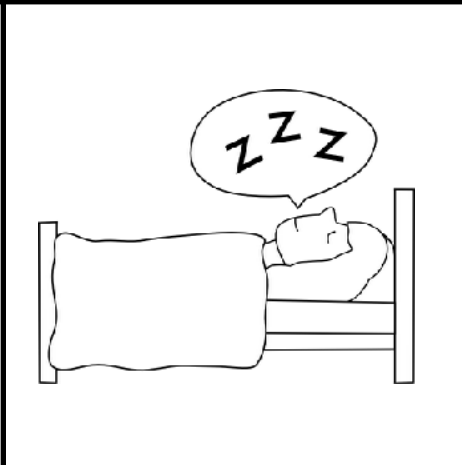
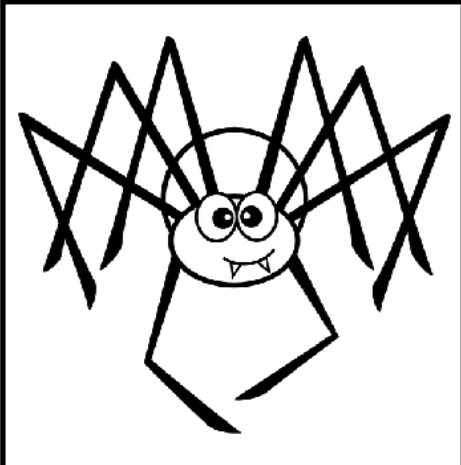
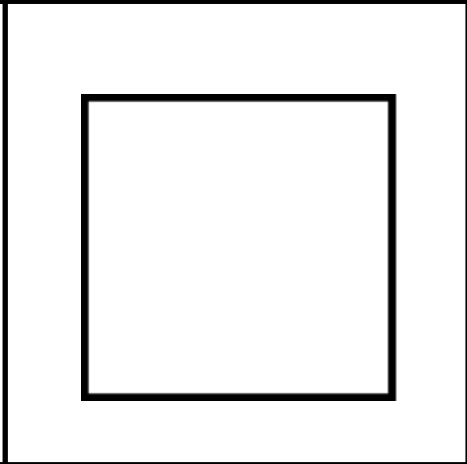
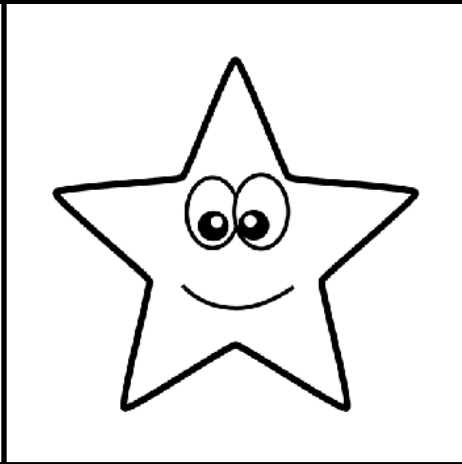
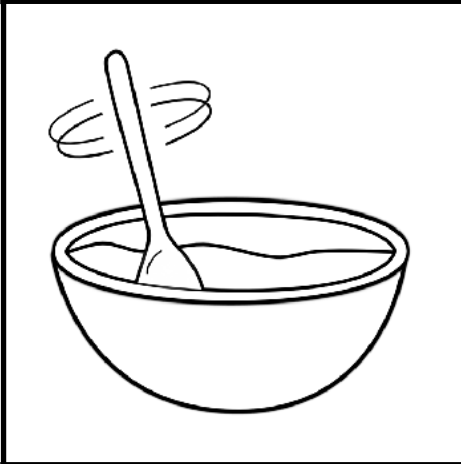
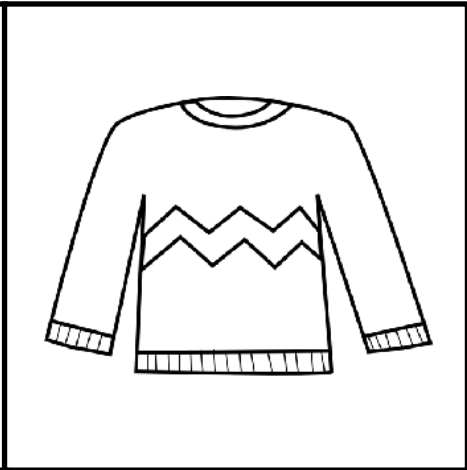
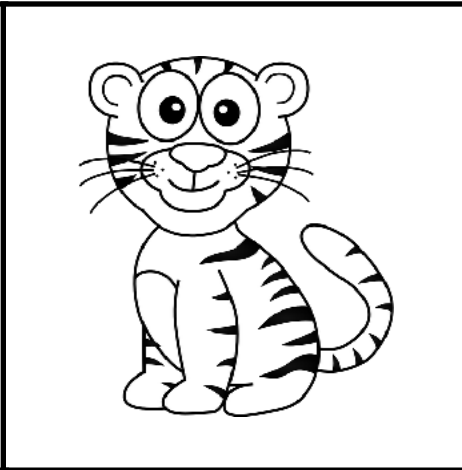
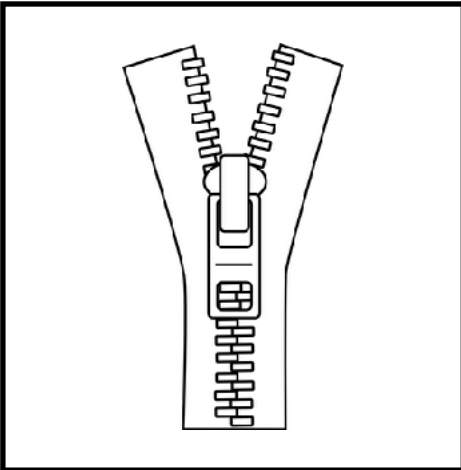

# Tic-Tac-Toe

Cut out the boxes on the page that follows. Then, place the x's and o's on the board as you play tic-tac-toe with a partner.

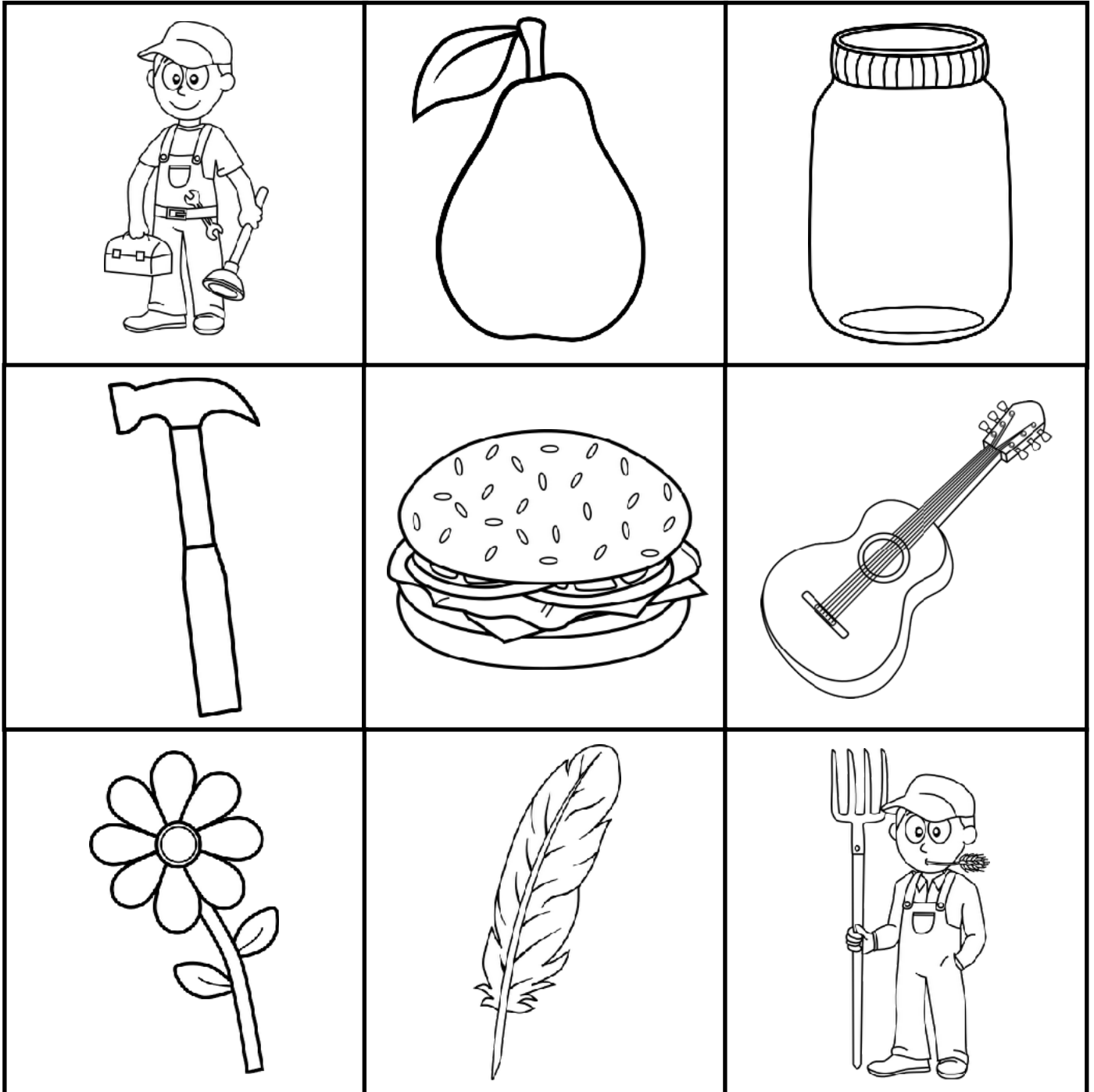



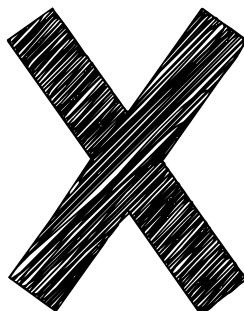
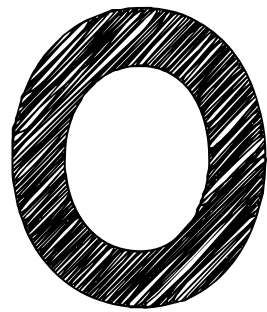
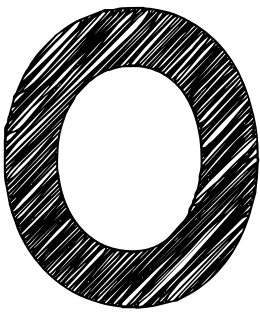
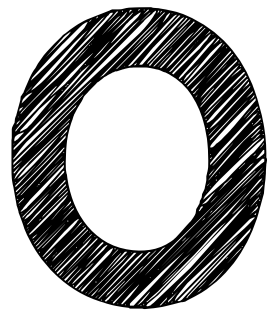
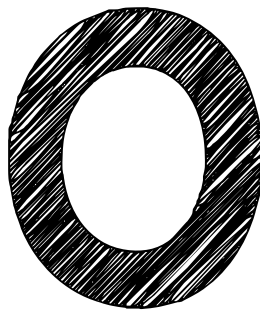
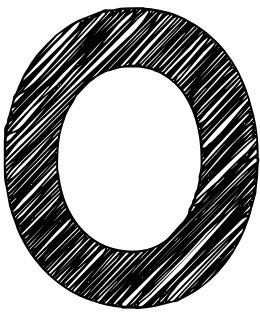
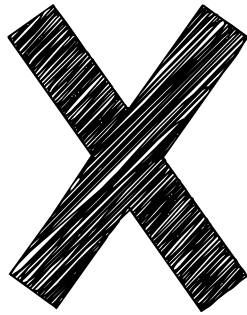
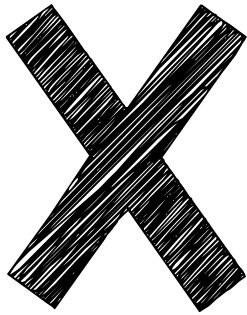

Color or dab a dot, each time you say a word that is pictured.

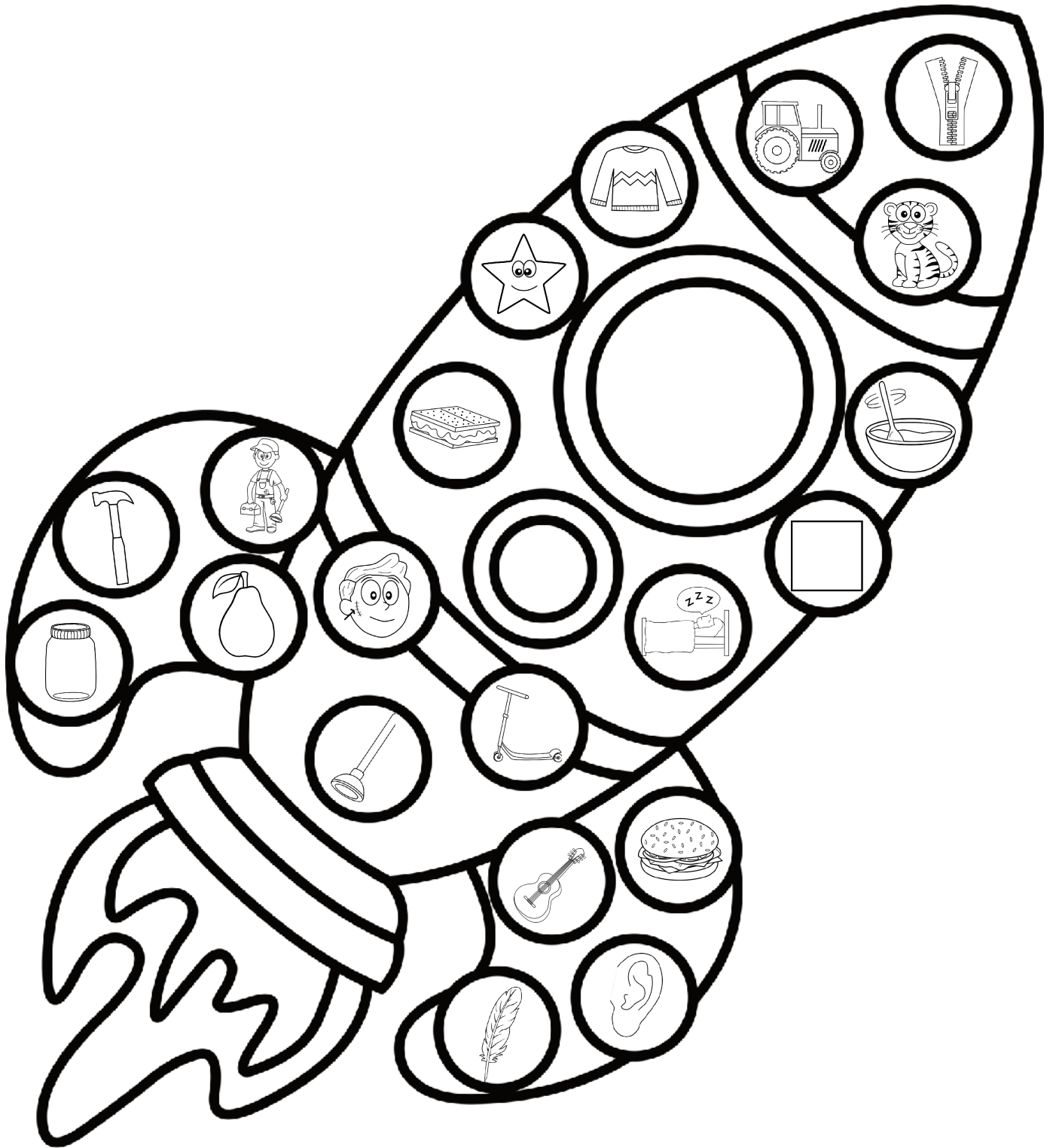

Each time you say a word that is pictured, color or dab a dot.

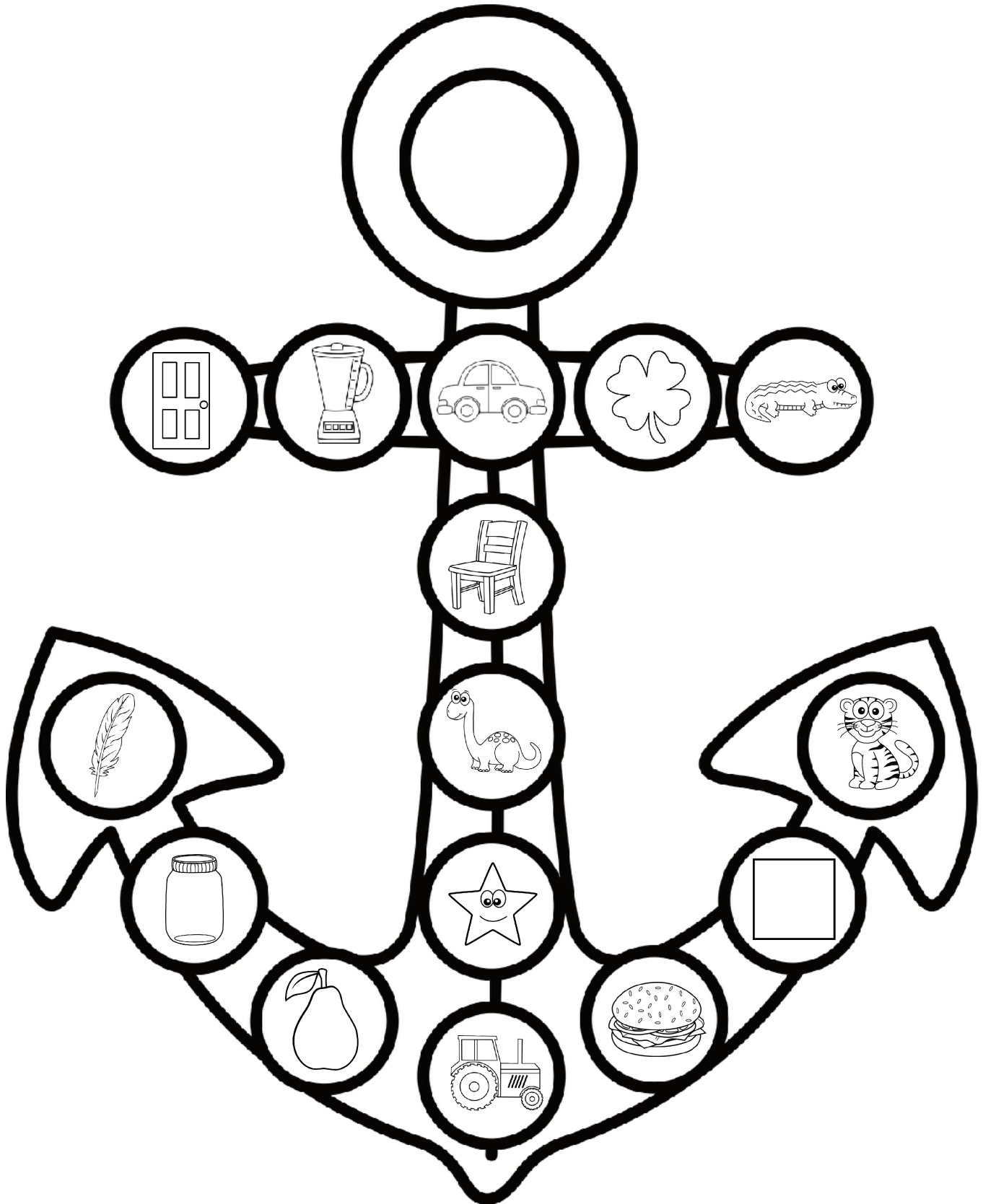

Use a pencil to secure a paper clip over the middle of the spinner. Then, spin the paper clip. When it stops, say the word that word in a sentence, then color it.

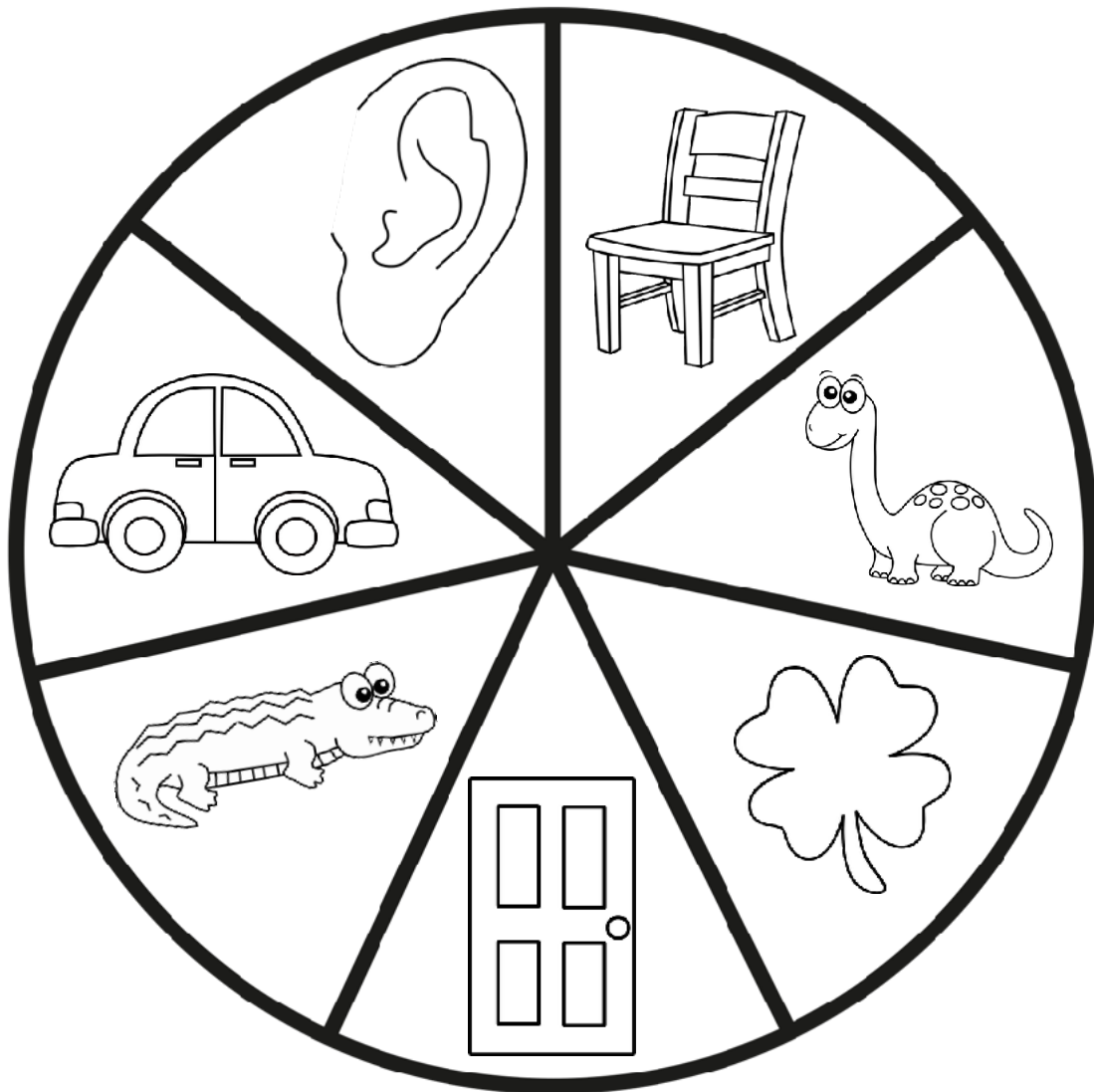

Cut apart the puzzle pieces. Put them back together, while making up a silly story using the words pictured.

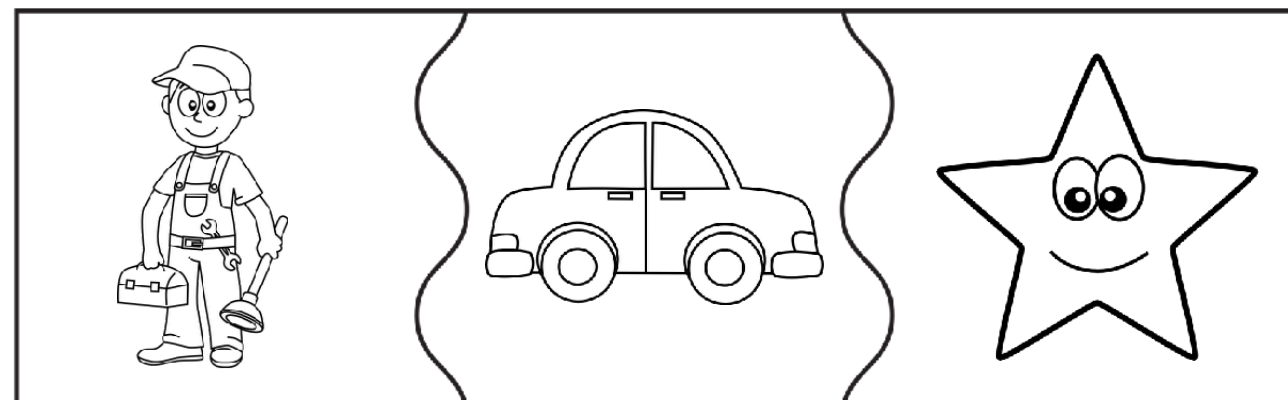
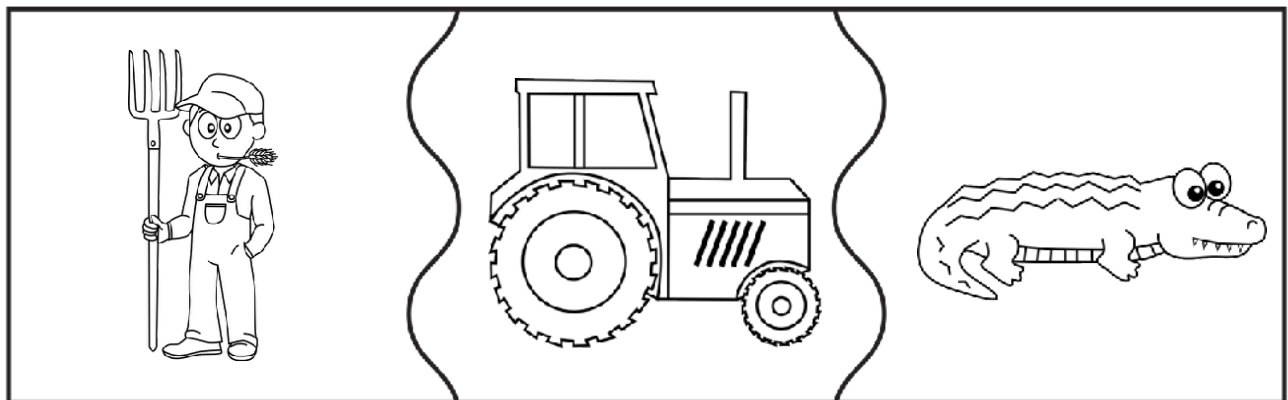
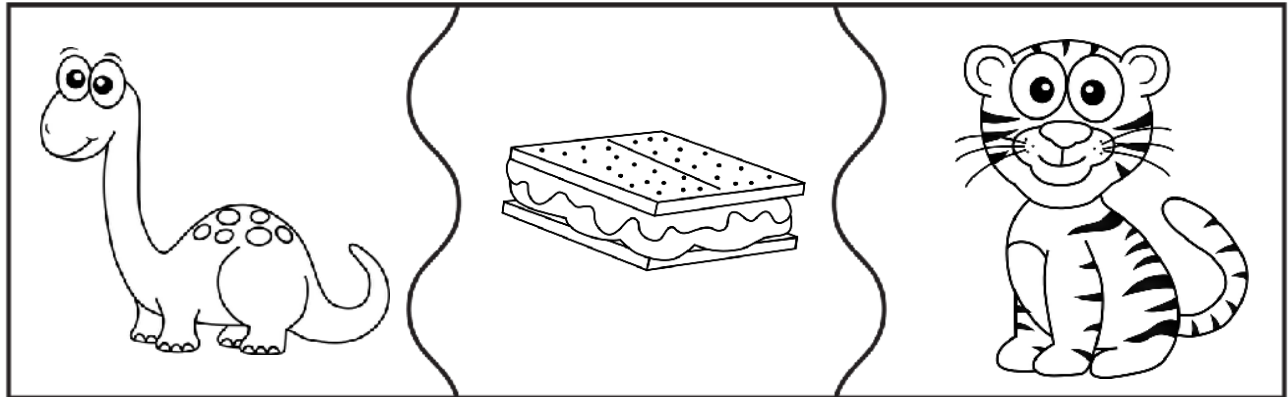

**Articulation**

**Homework**

**Helpers**

*/R/ -sound  
mixed positions*

Cut out the cards below and on the page that follows. Practice working on the /r/ sound while you play "memory".

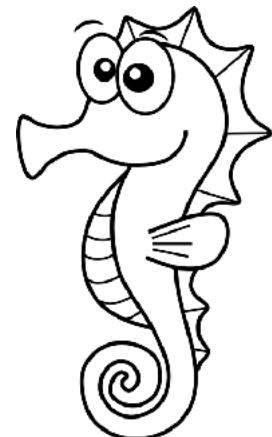
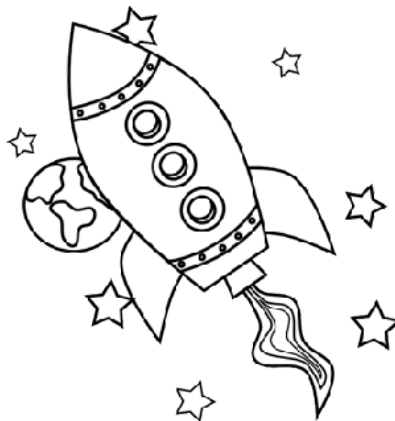
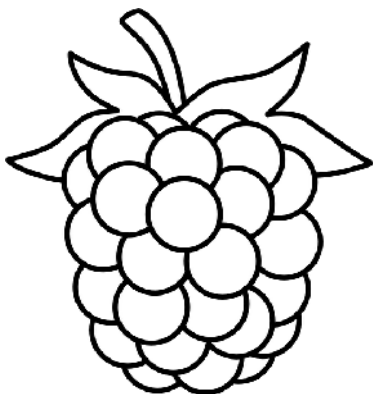
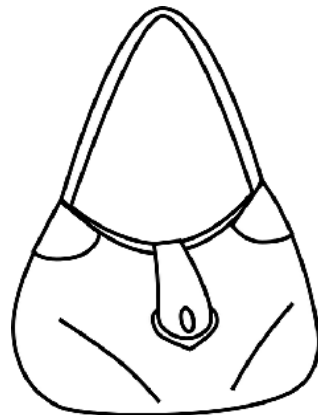
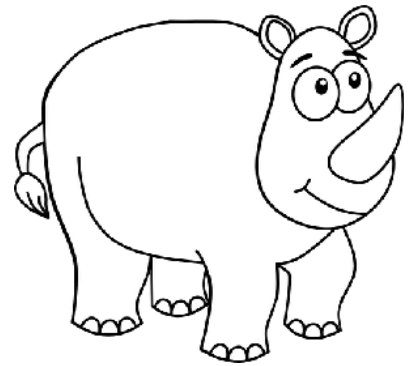
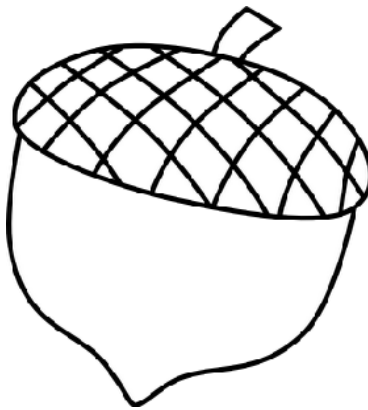
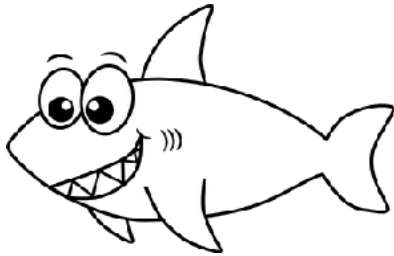
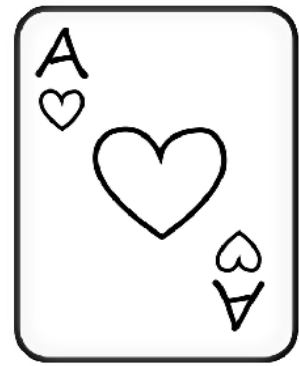
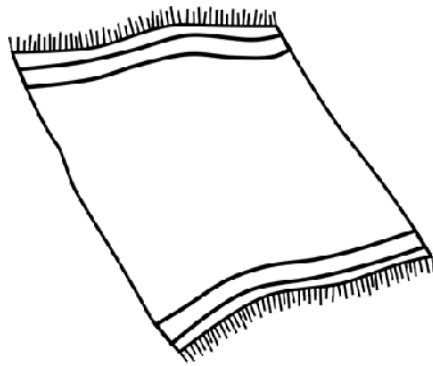



Cut out the cards below and practice working on the /r/ sound while you play "memory".

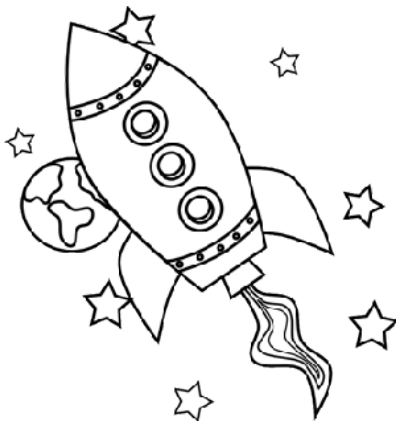
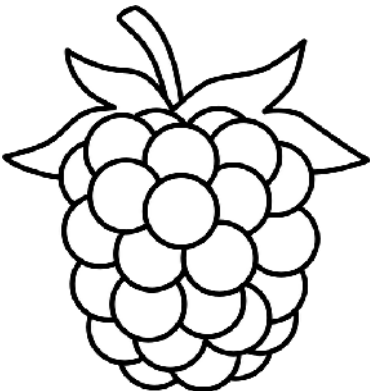
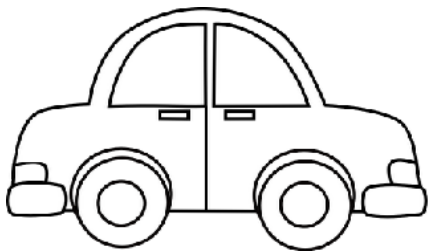
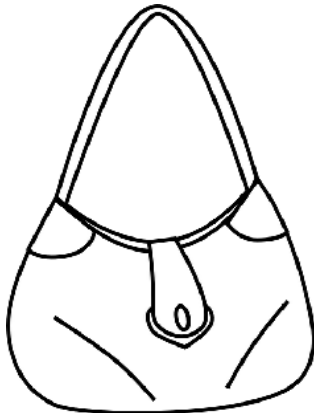
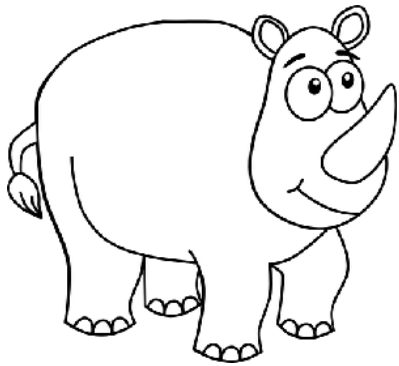
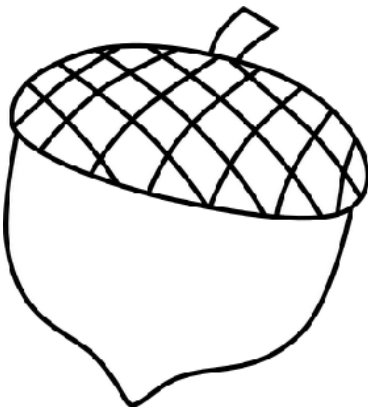
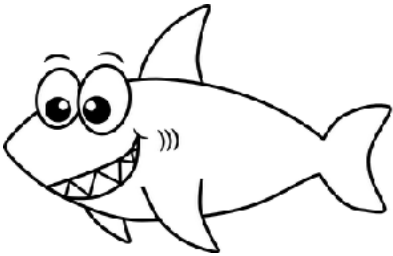
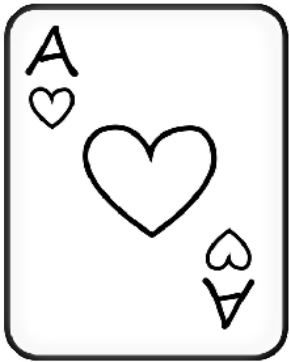
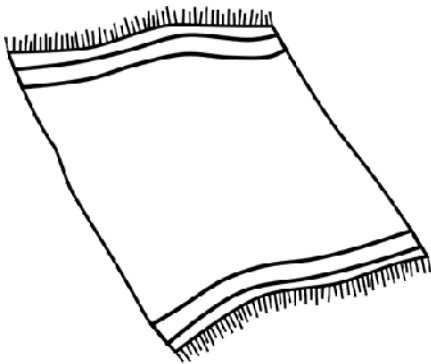



## Tic-Tac-Toe

Cut out the boxes on the page that follows. Then, place the x's and o's on the board as you play tic-tac-toe with a partner.

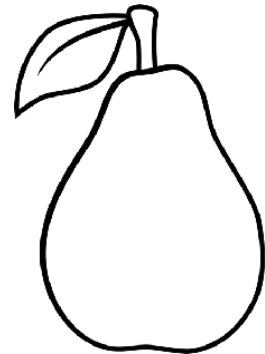
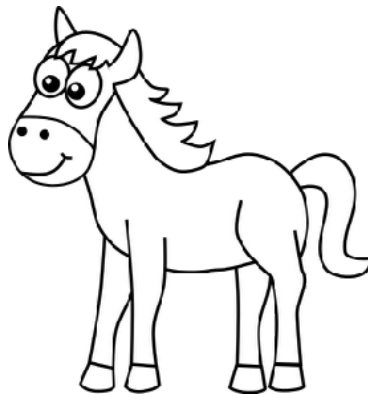
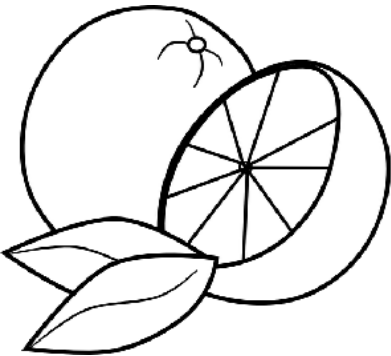
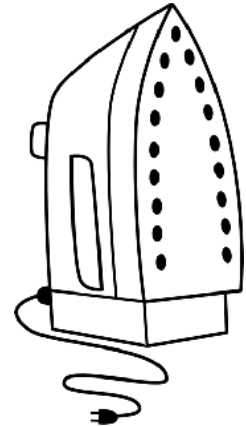
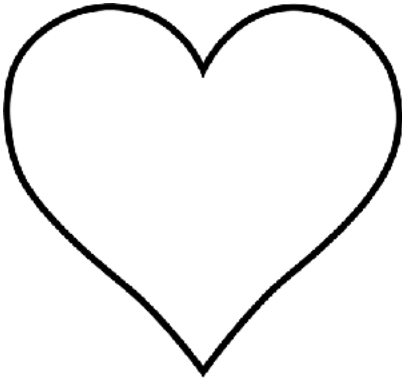
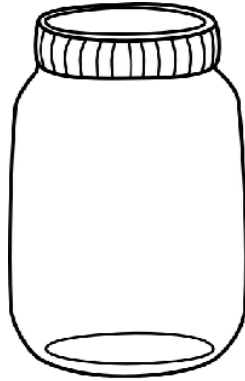
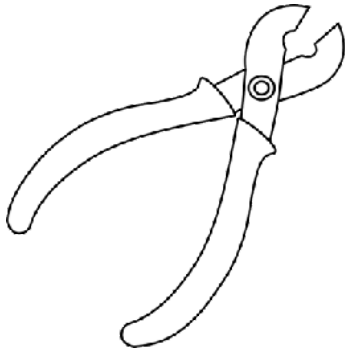

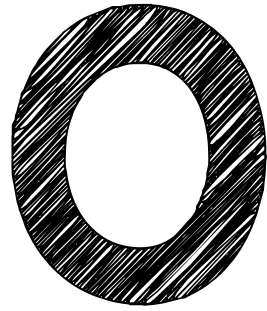
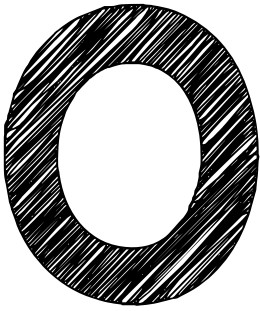
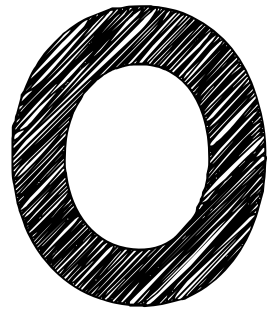
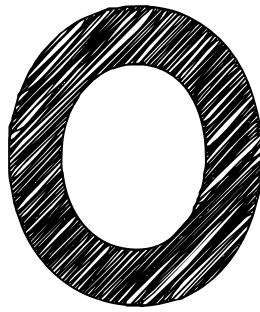
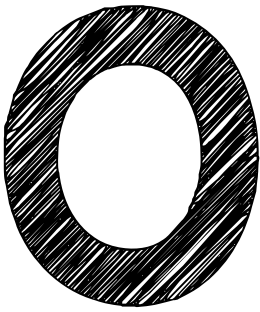
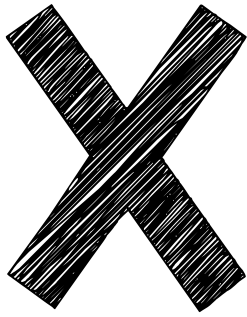

Roll the die, say a word, then color it in! Continue until all of the spaces are filled.

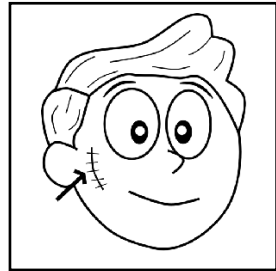
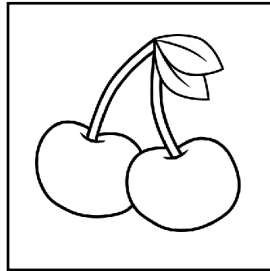
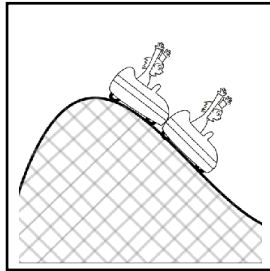
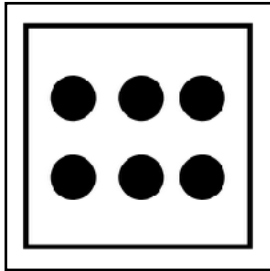
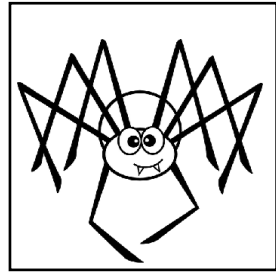
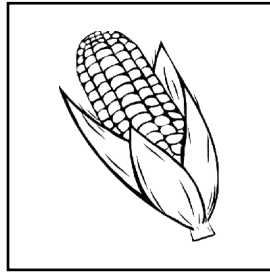
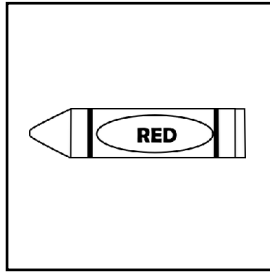
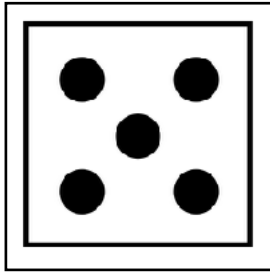
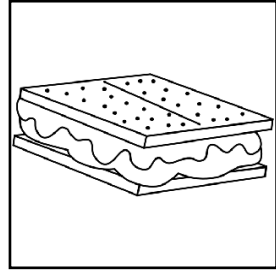
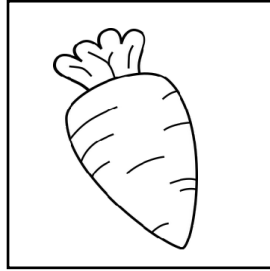
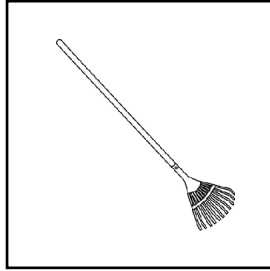
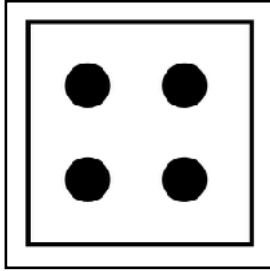
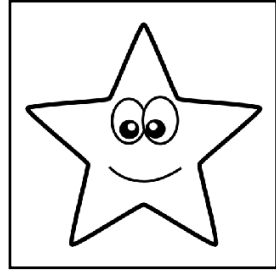
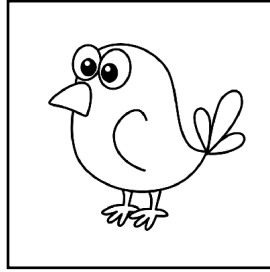
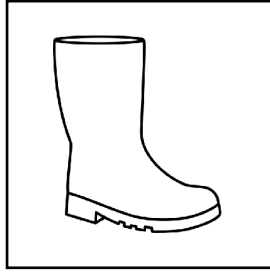
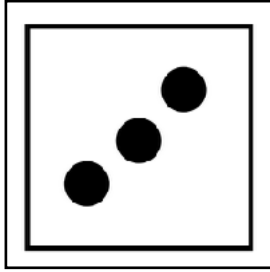
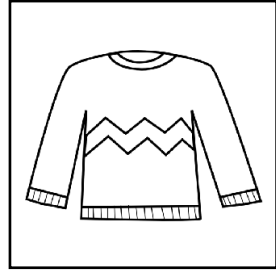
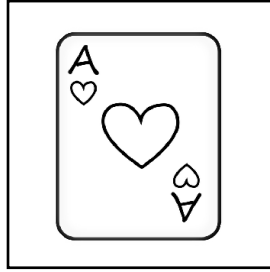
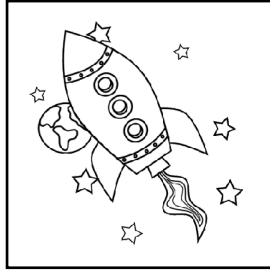
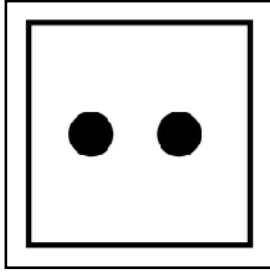
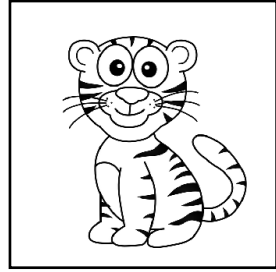
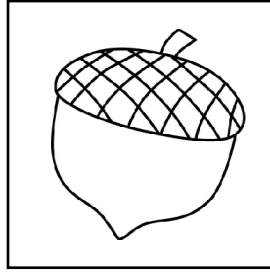
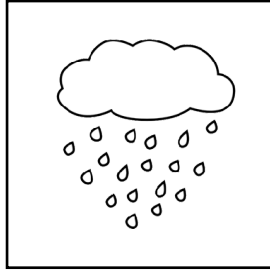
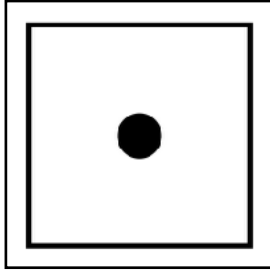

Use a pencil to secure a paper clip over the middle of the spinner. Then, spin the paper clip. When it stops, say the word that it lands on three times, then color it.

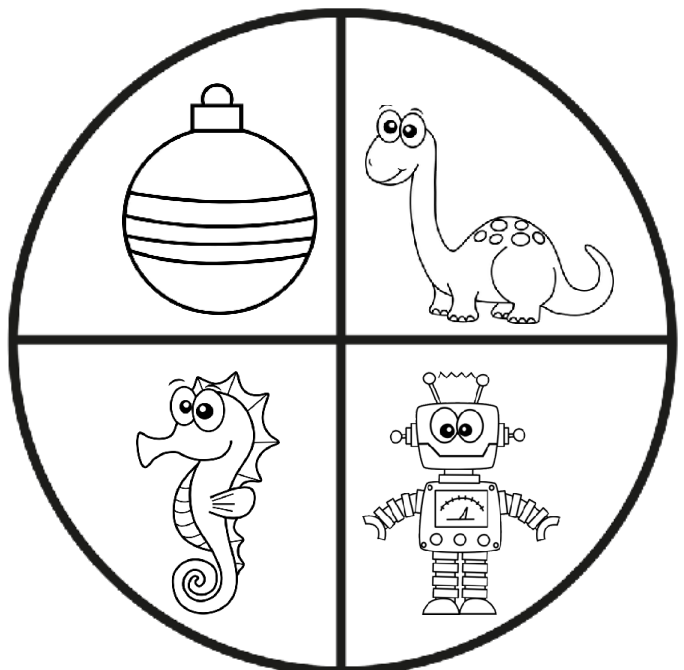
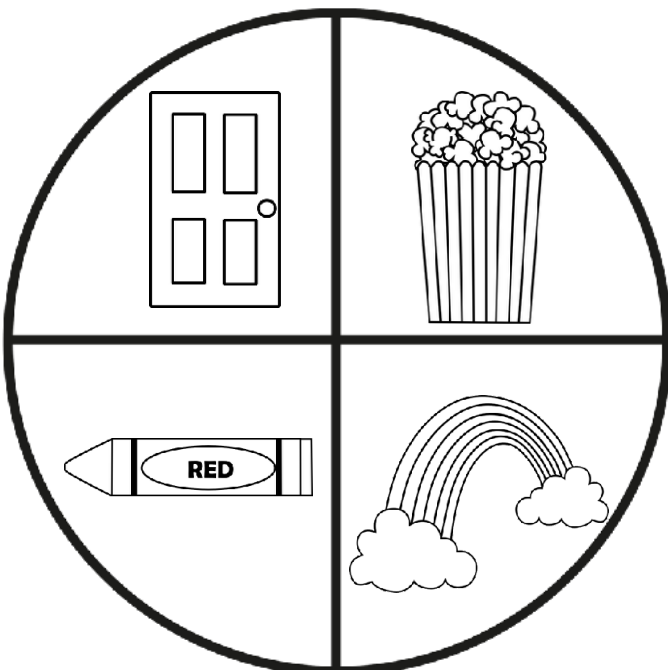
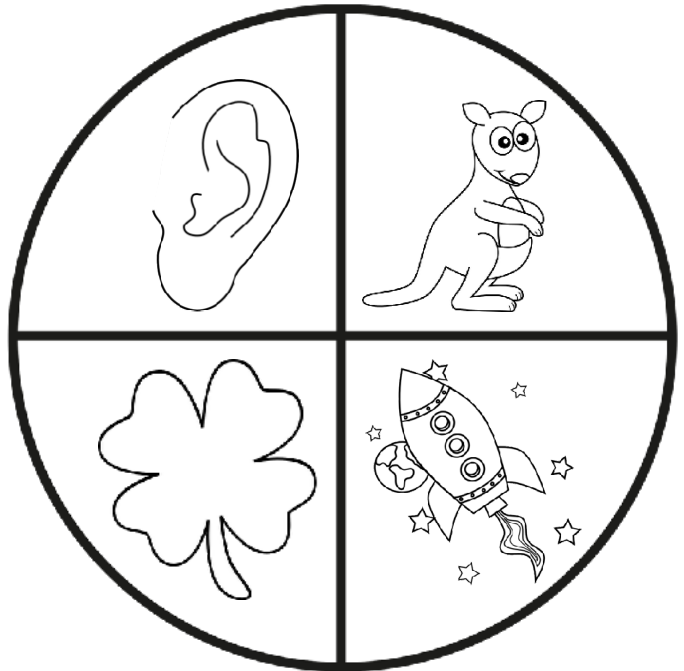
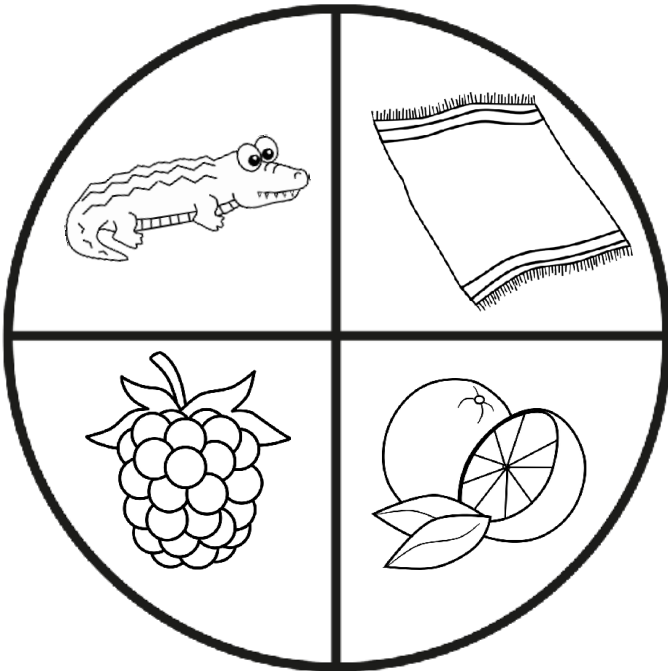

Color or dab a dot, each time you say a word that is pictured.

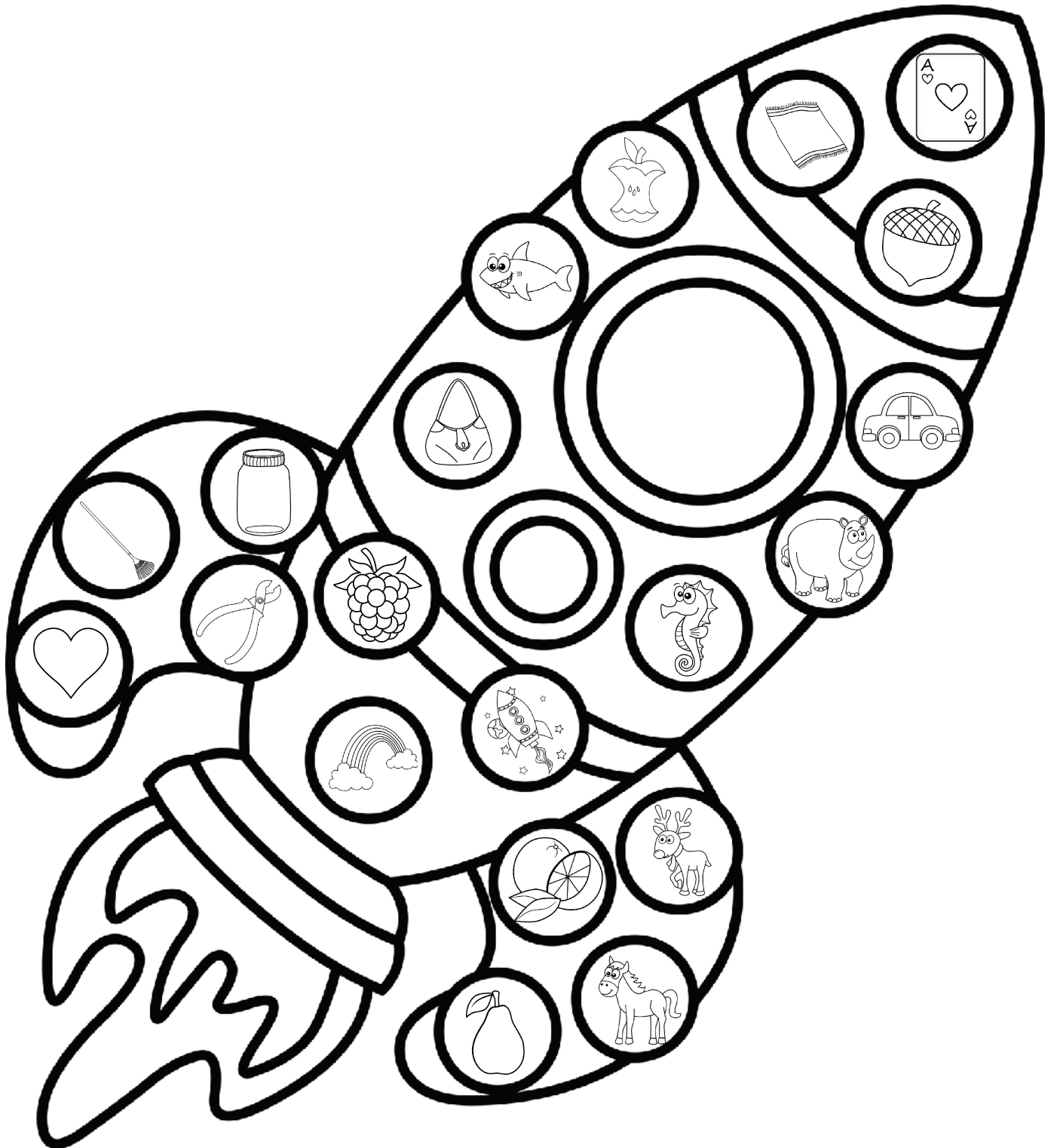

Each time you say a word that is pictured, color or dab a dot.

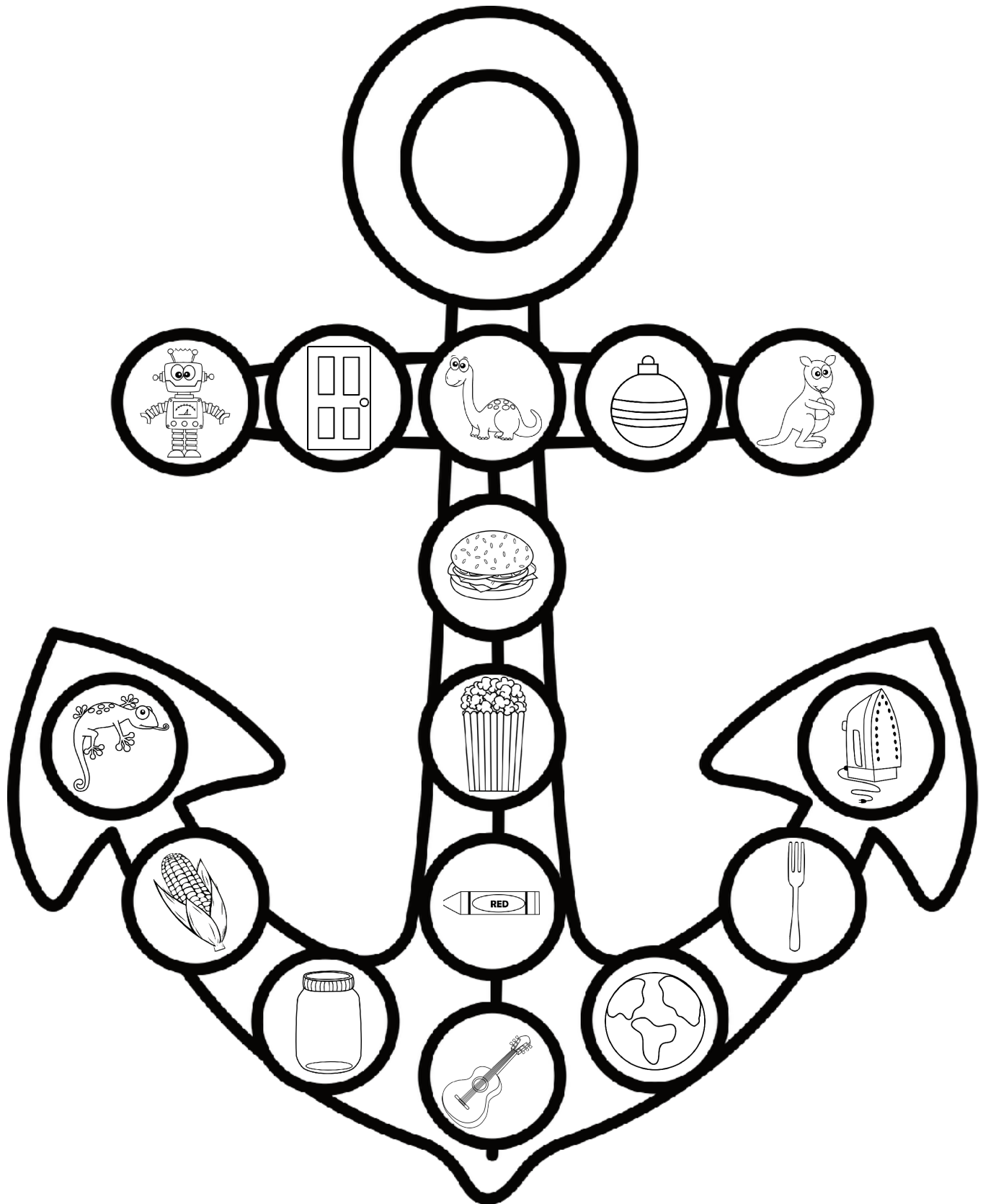

**Cut apart the puzzle pieces. Put them back together, while making up a silly story using the words pictured.**

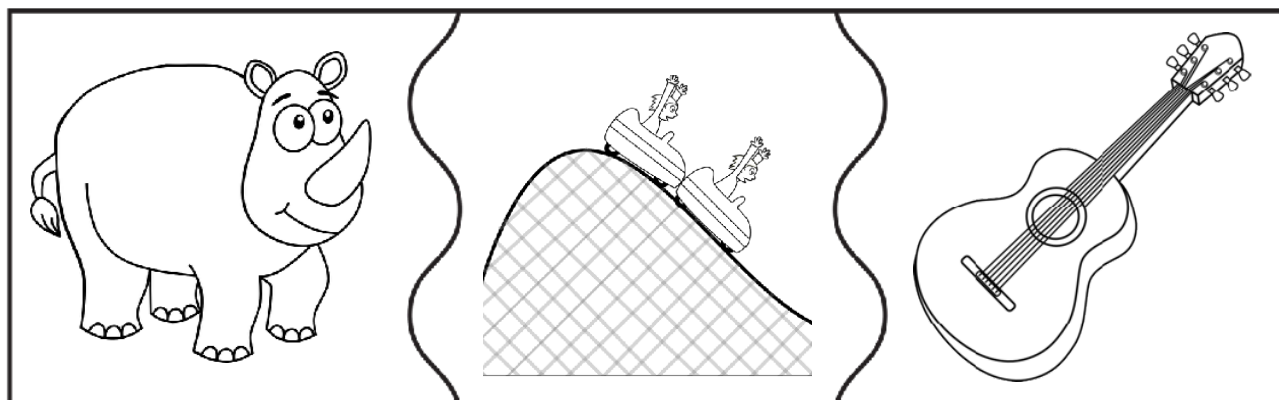
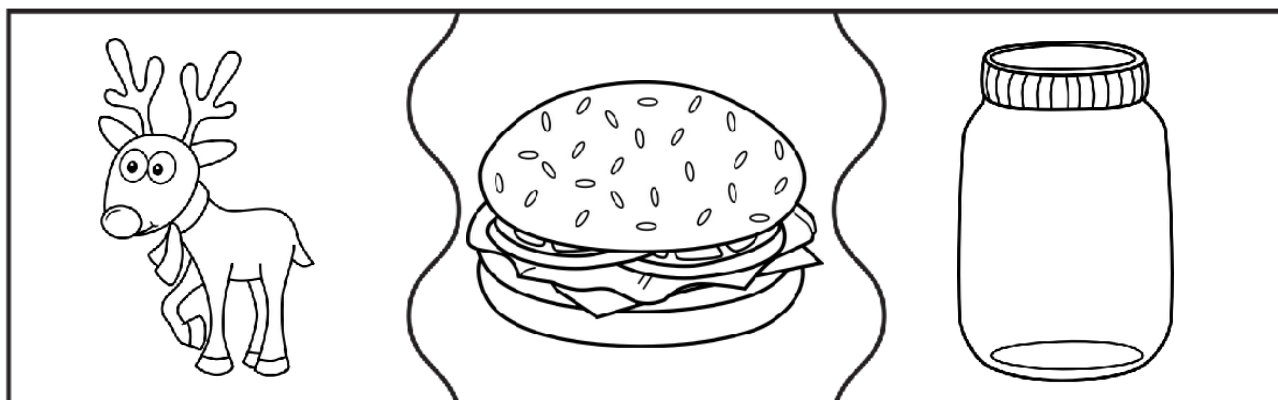
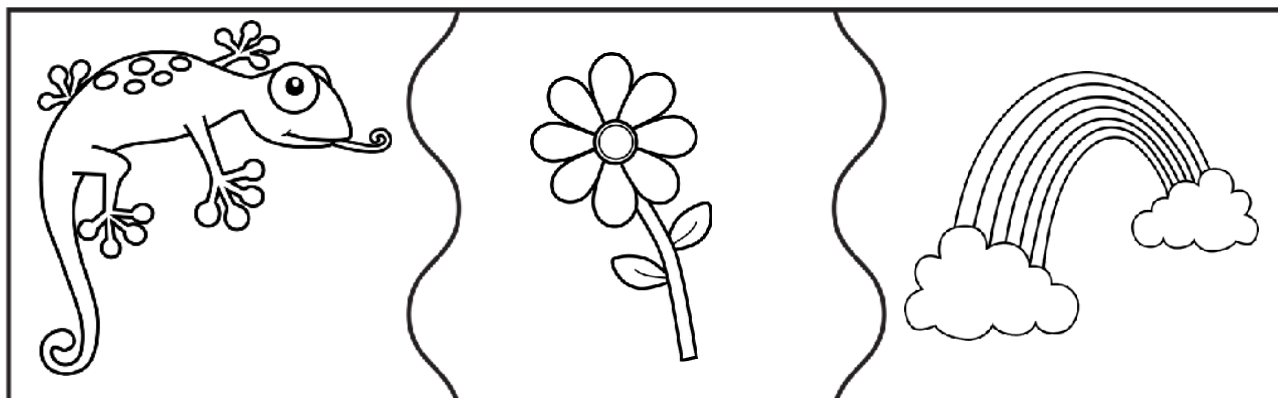

Cut apart the puzzle pieces. Put them back together, while making up a silly story using the words pictured.

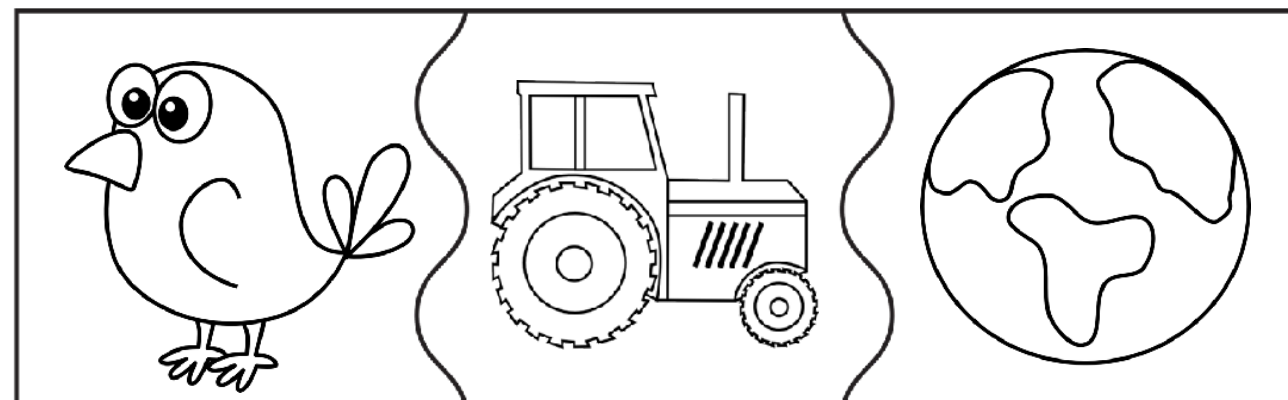
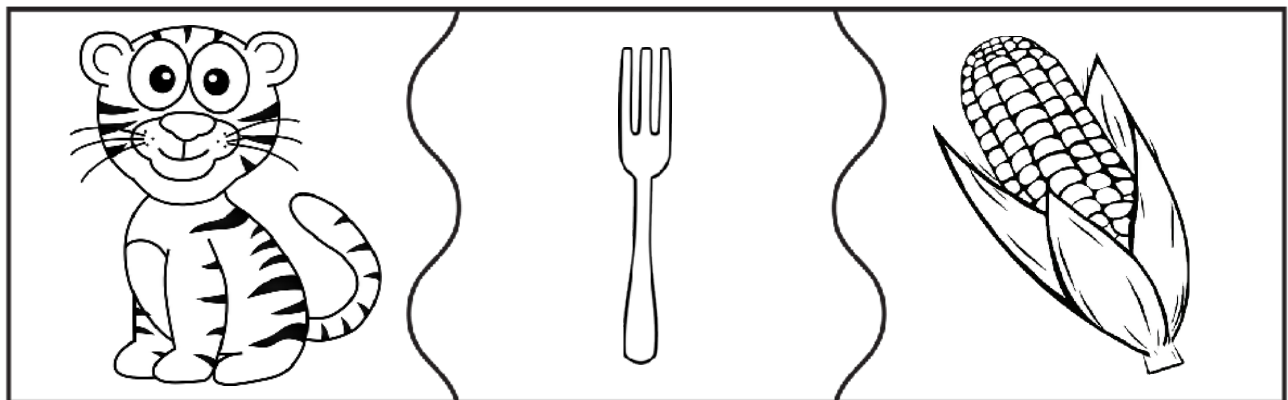
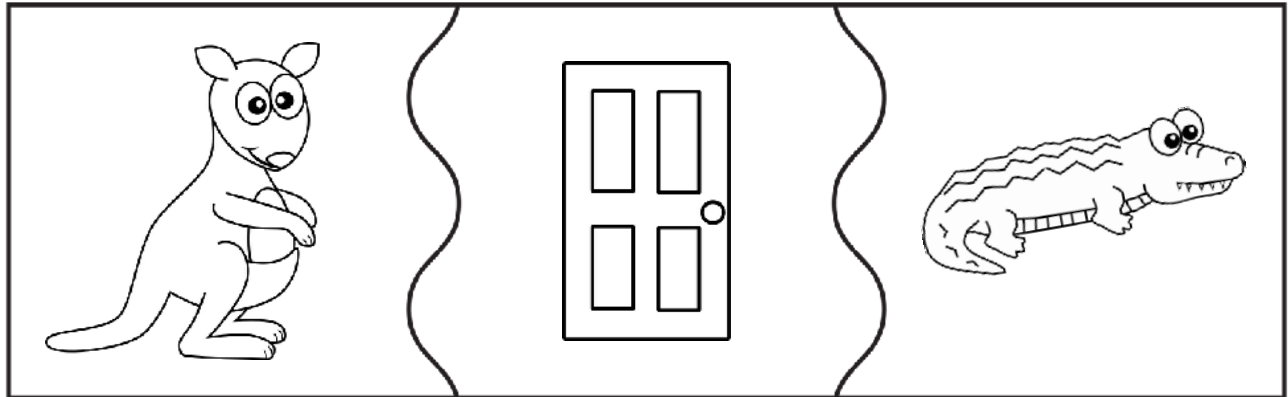



## Credits

